



Box cavalli 03

3,5x9-44

DISEGNI TECNICI

BOX CAVALLI 03 3,5x9-44

Boarding joist plan

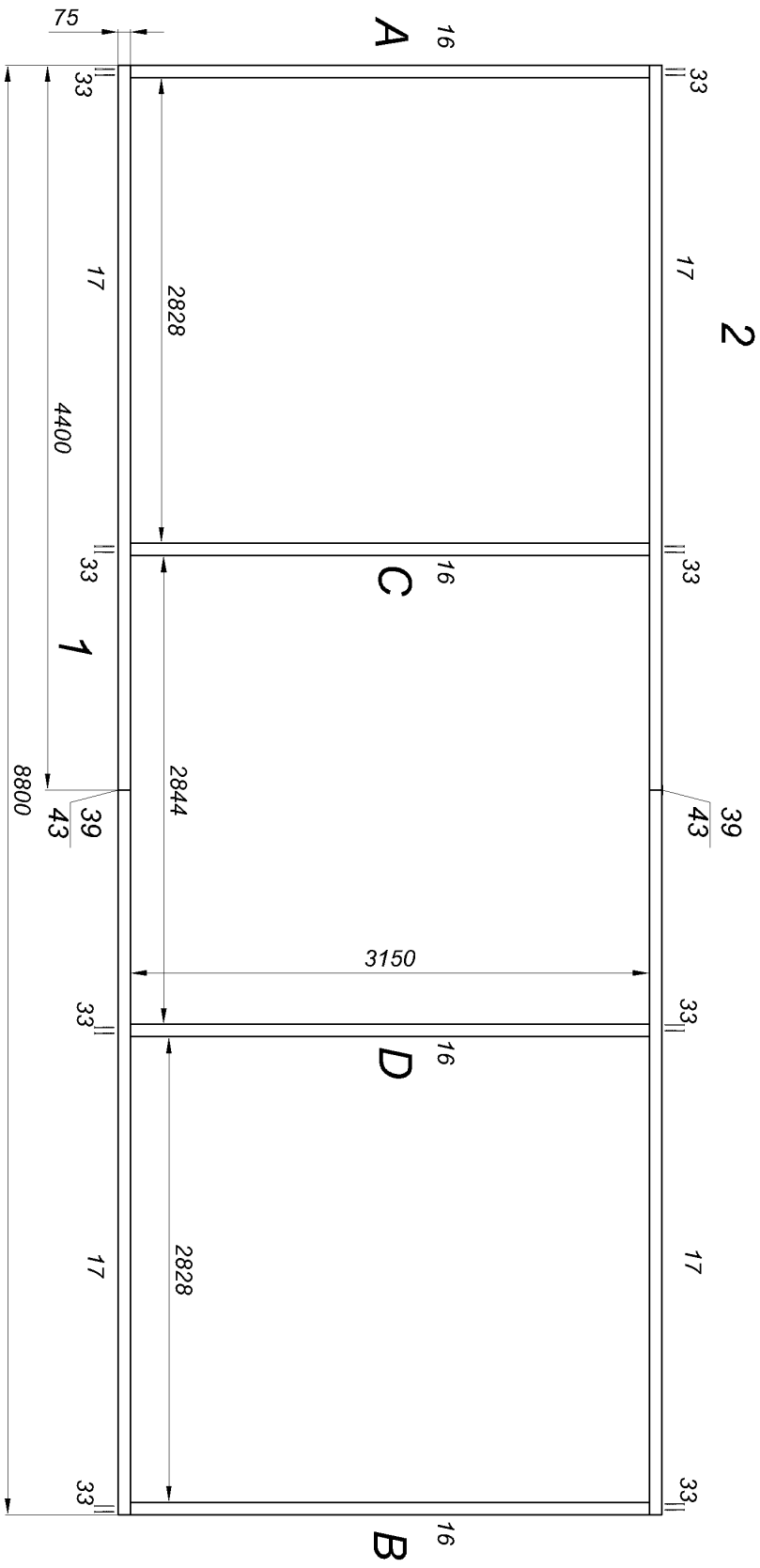

Secure the boards to the ground with anchor screws

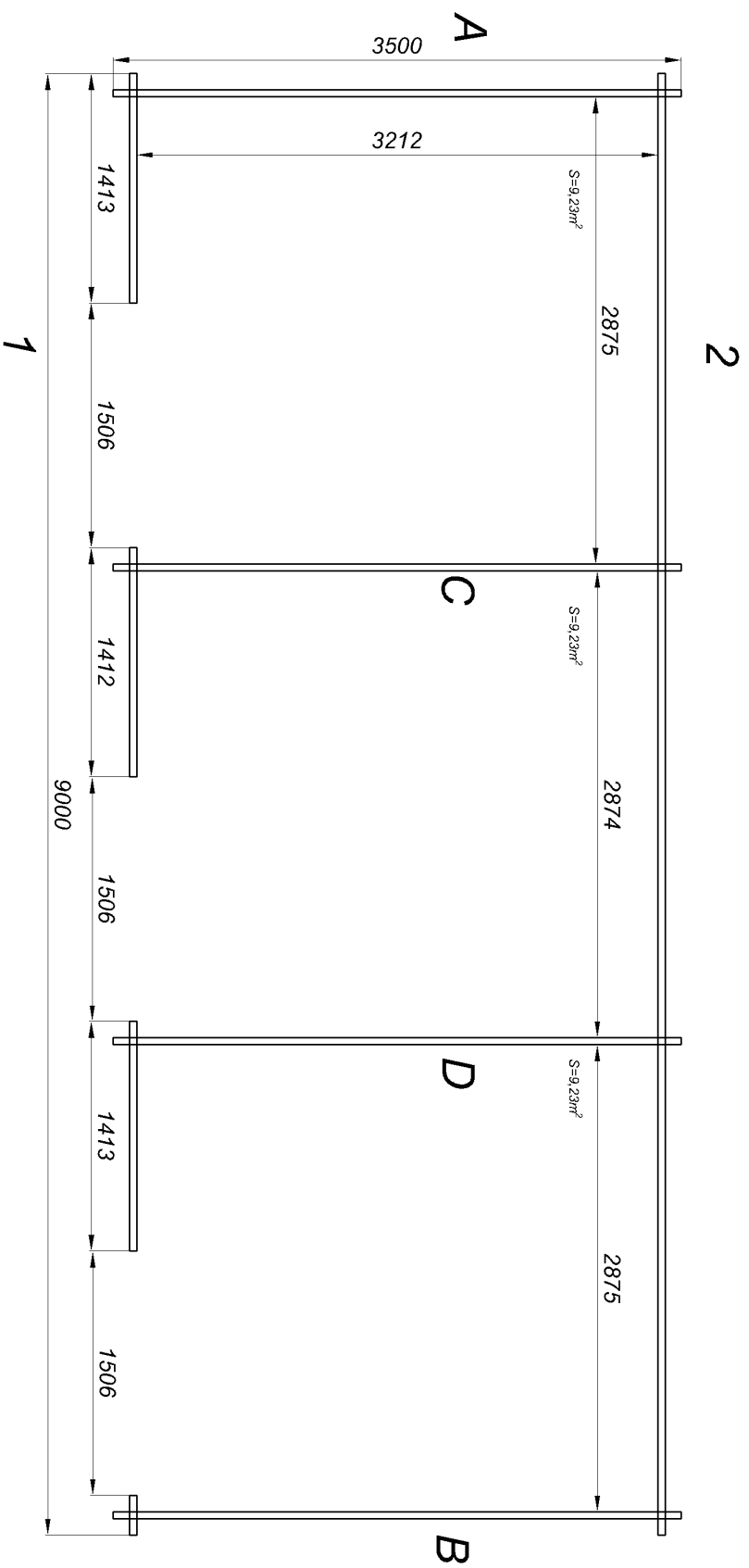

BOX CAVALLI 03 3,5x9-44

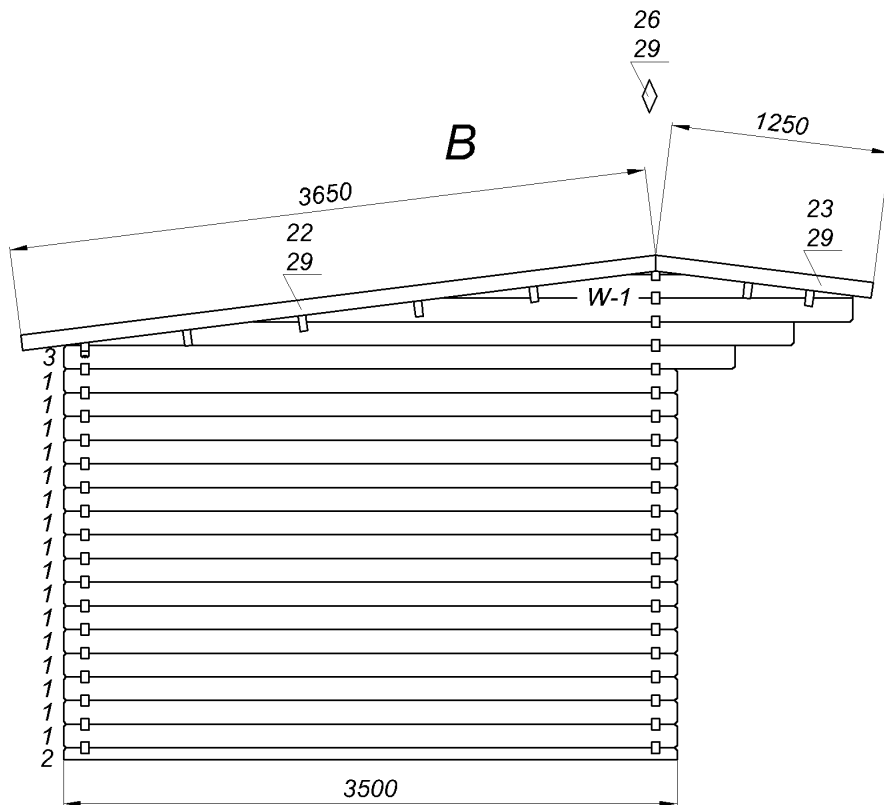
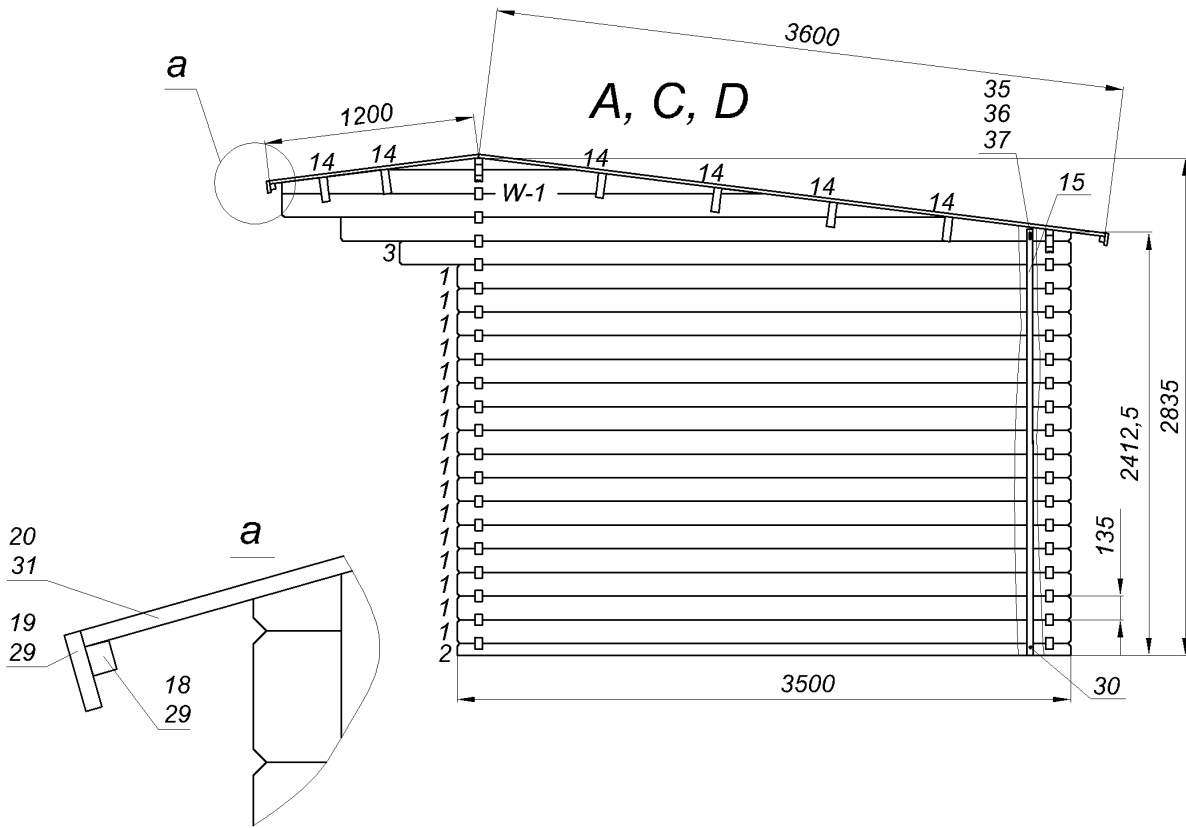

BOX CAVALLI 03 3,5x9-44

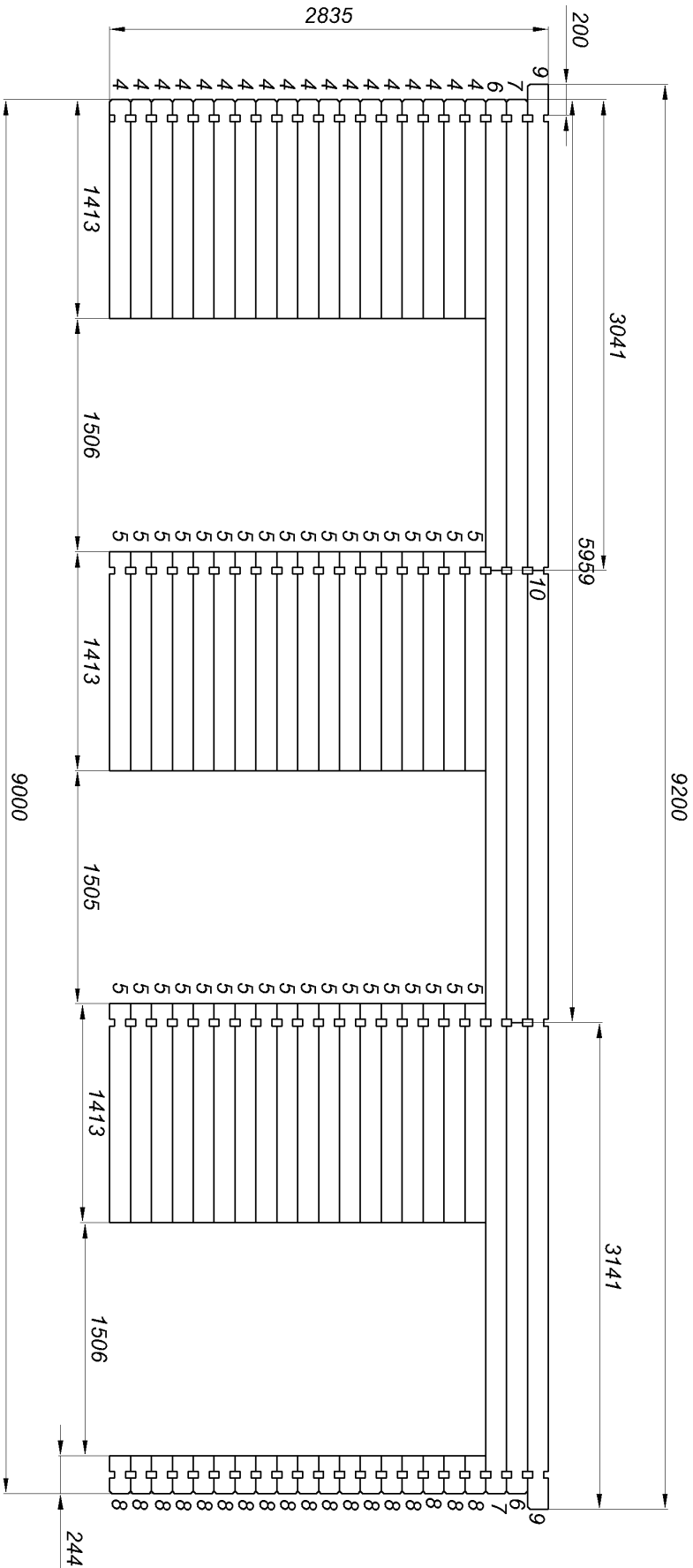

BOX CAVALLI 03 3,5x9-44

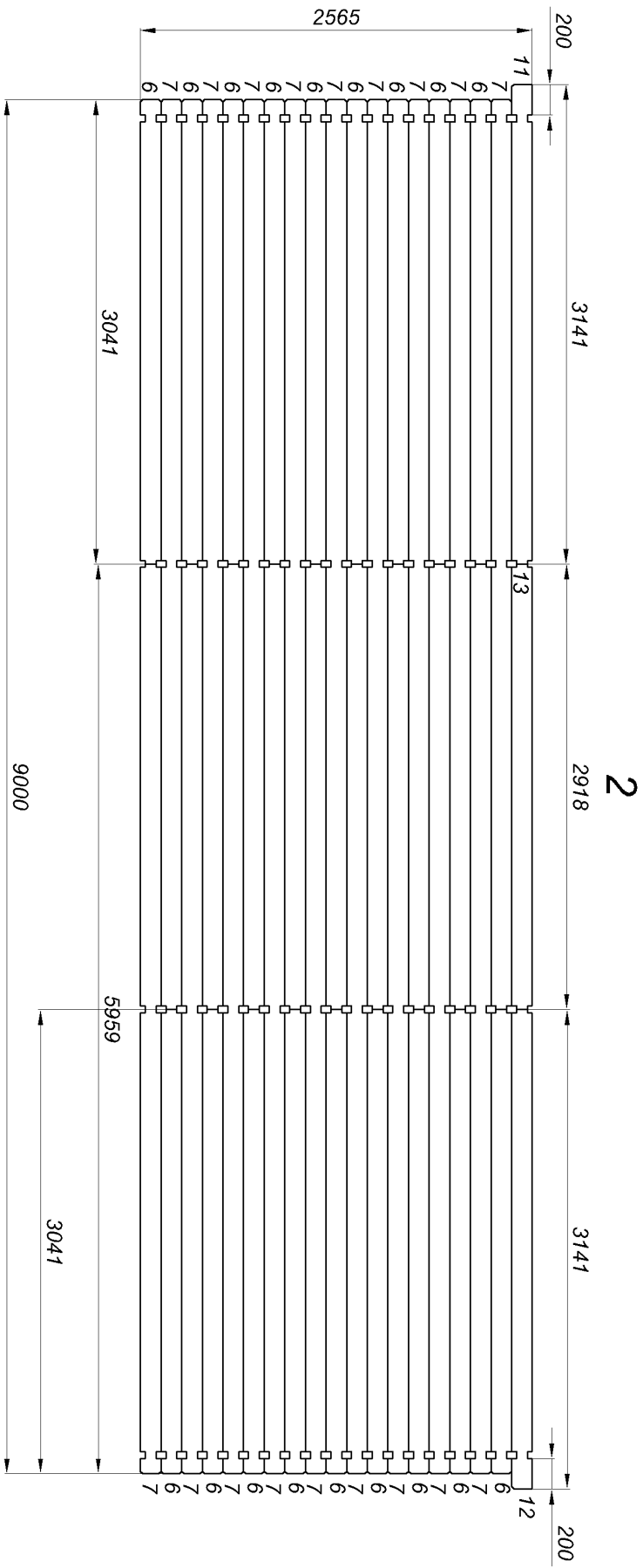

BOX CAVALLI 03 3,5x9-44

1

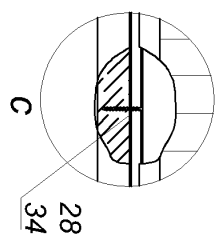
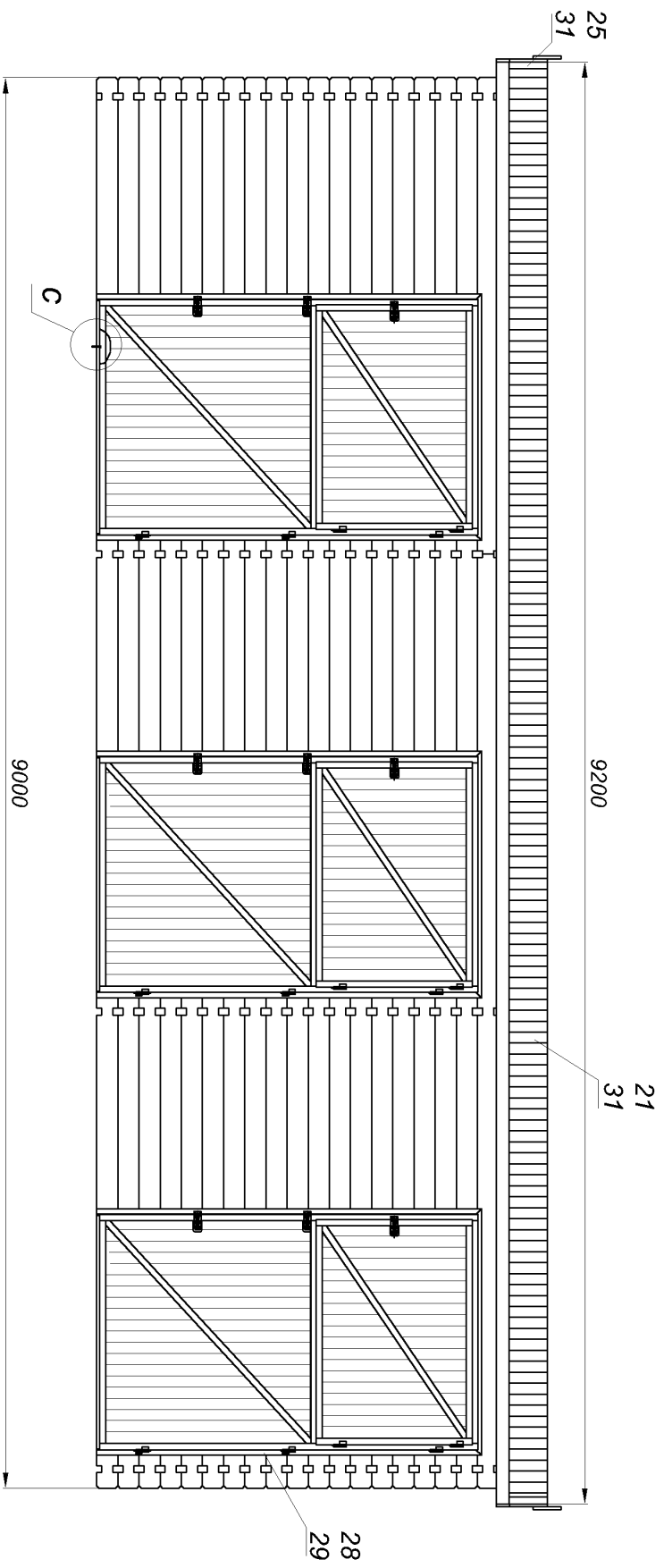

BOX CAVALLI 03 3,5x9-44

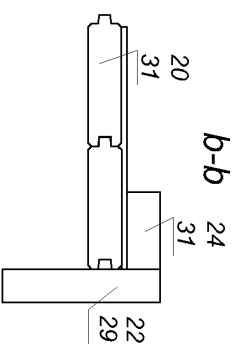
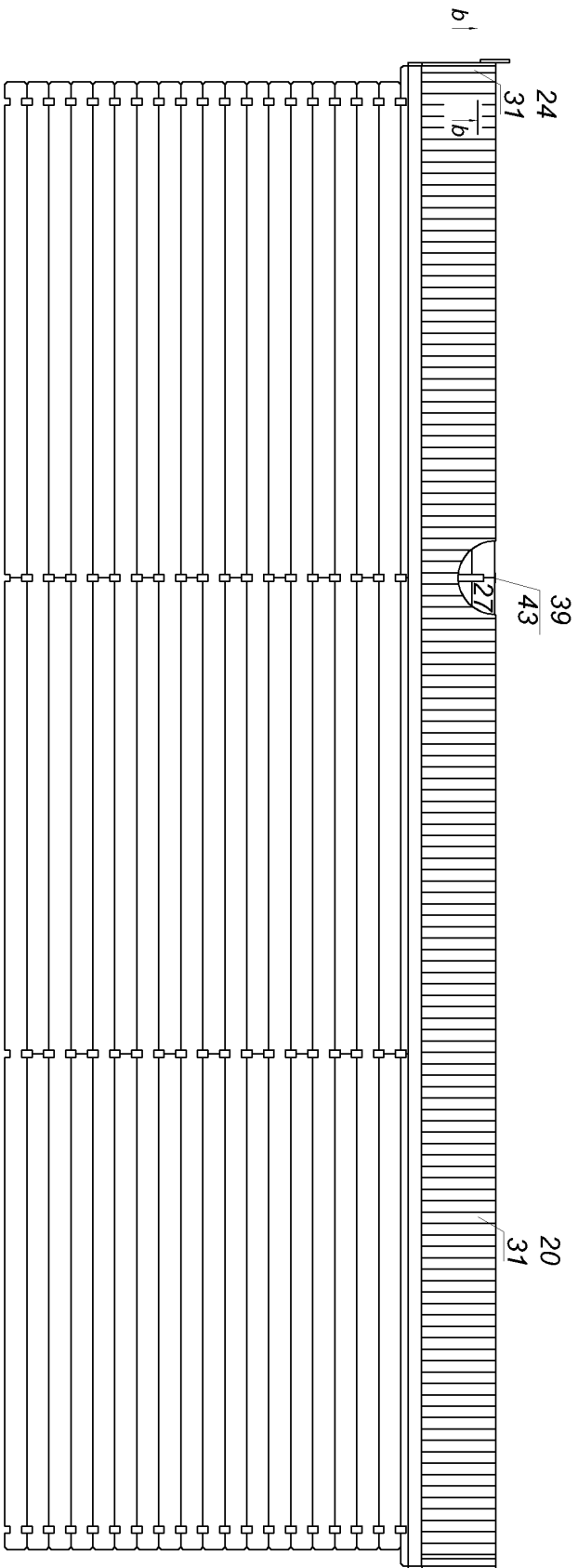

BOX CAVALLI 03 3,5x9-44

Vue extérieure
View from outside

