

DK 34 4,2x2,2

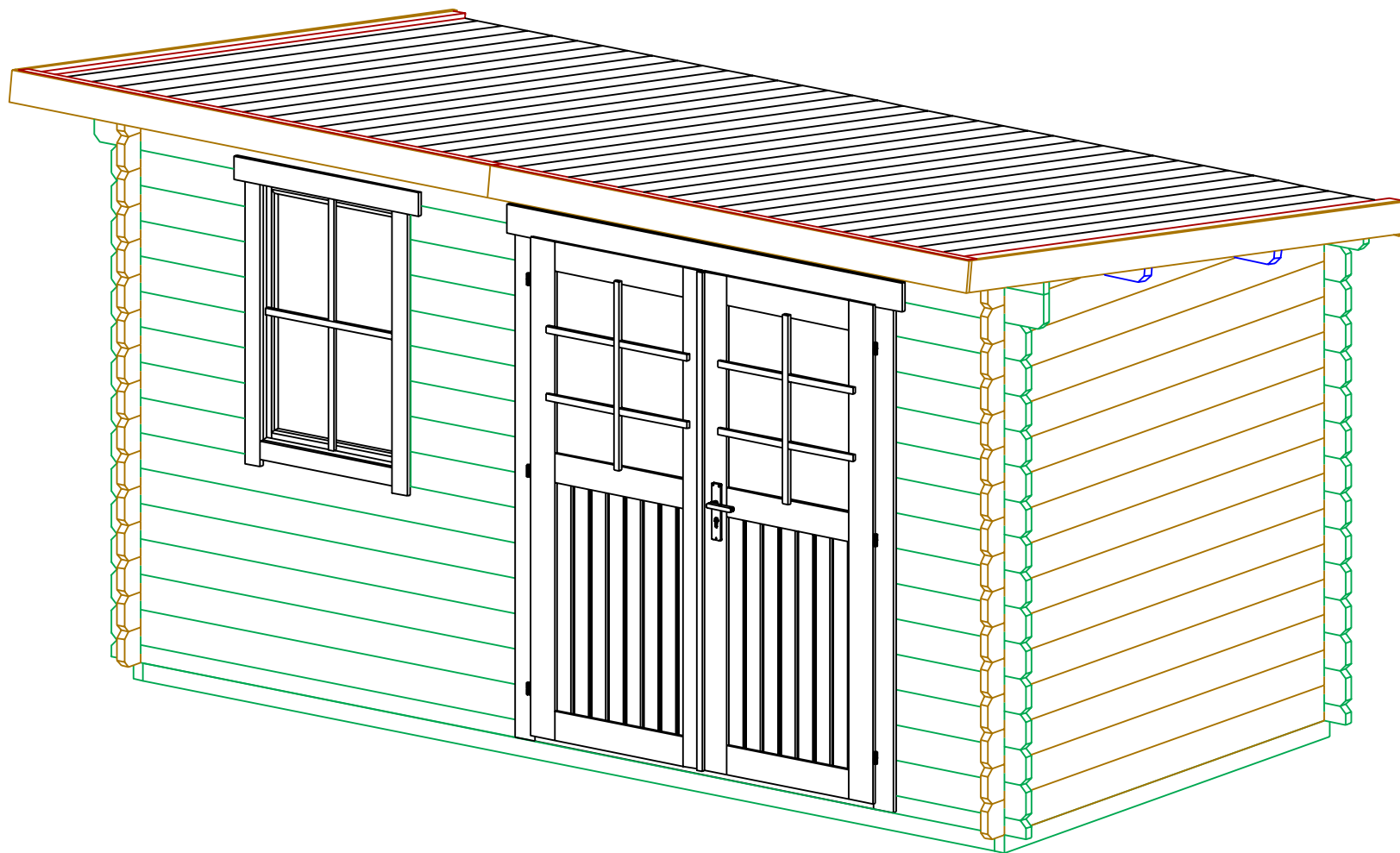

DK 34 4,2x2,2

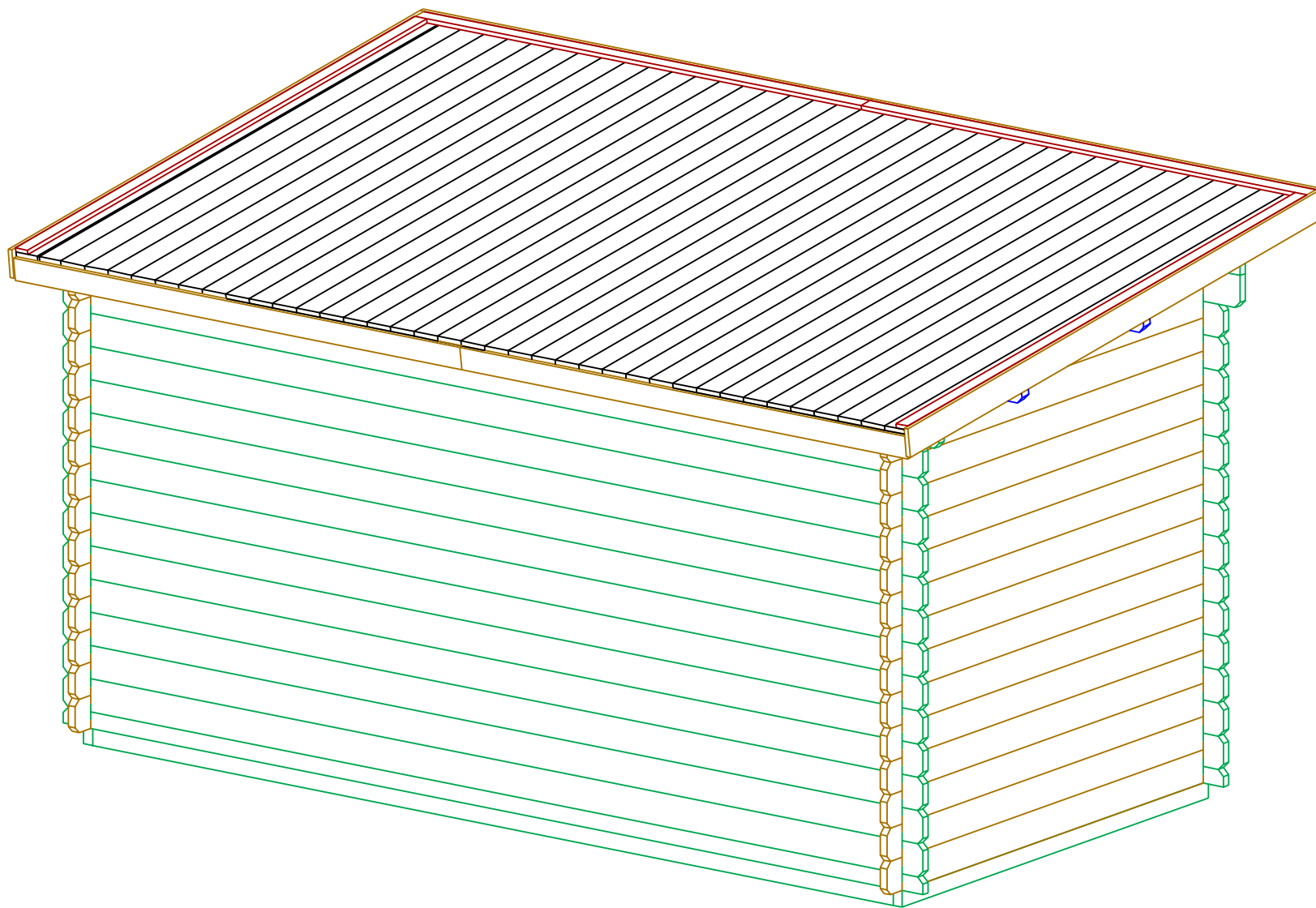

DK 34 4,2x2,2

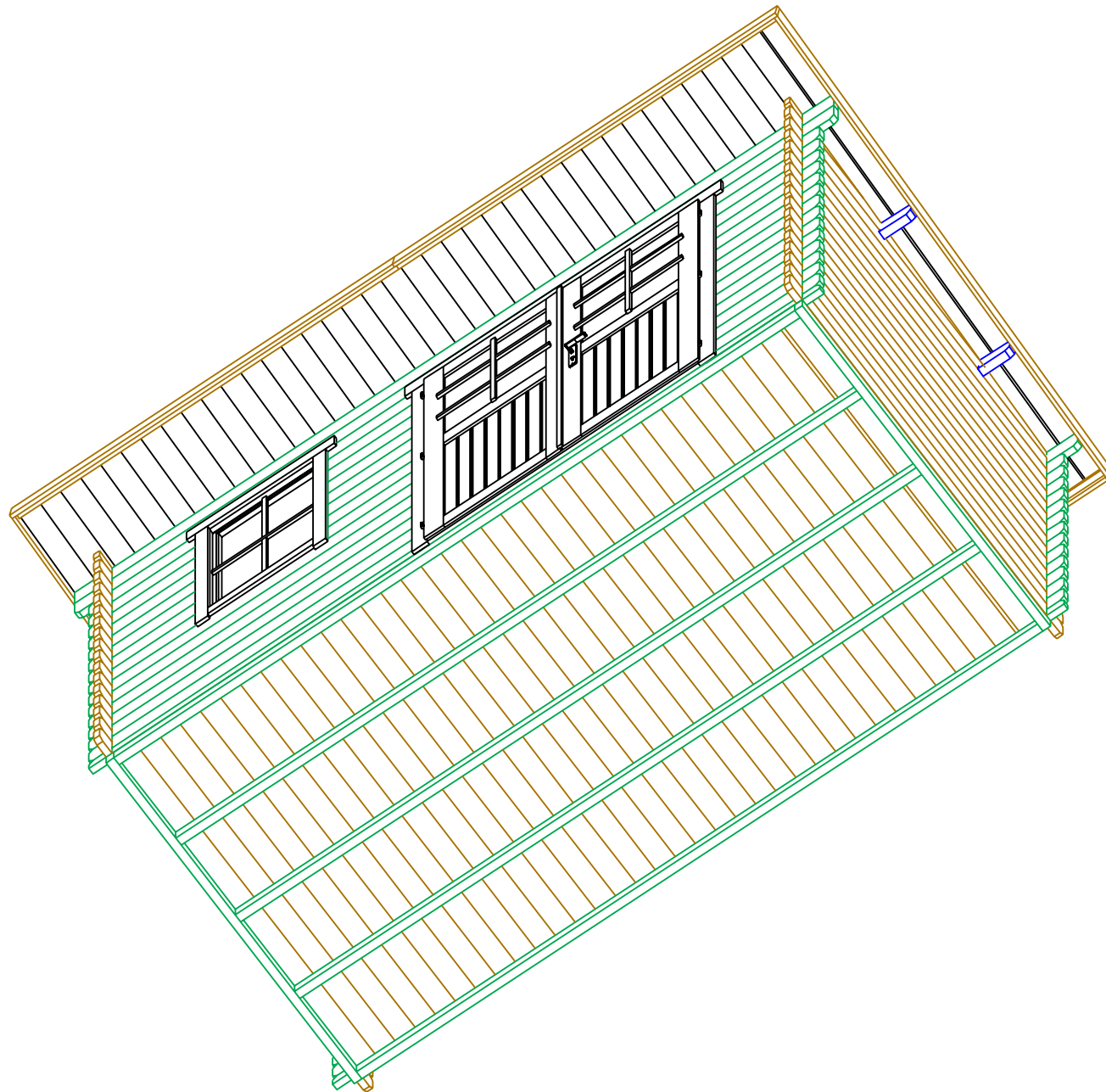

DK 34 4,2x2,2
Plan

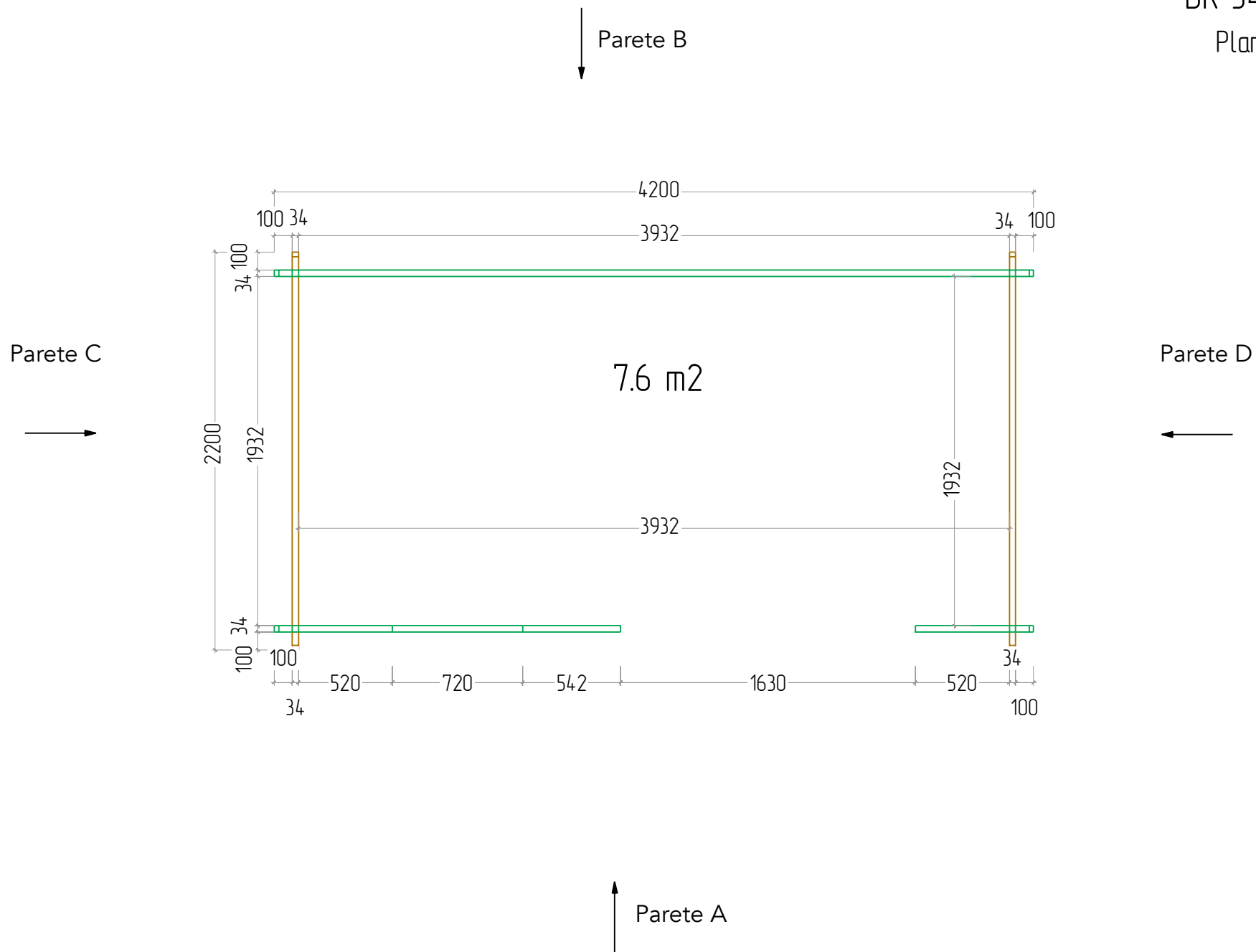

DK 34 4,2x2,2

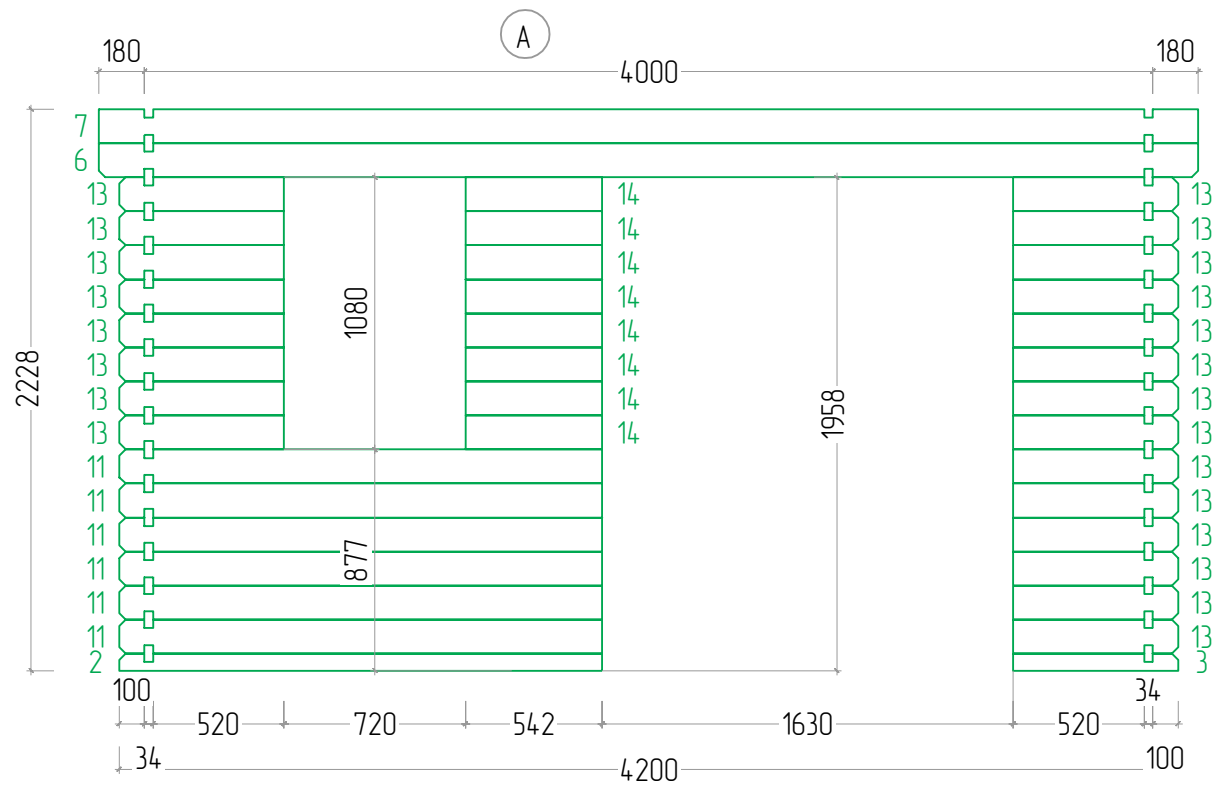

DK 34 4,2x2,2

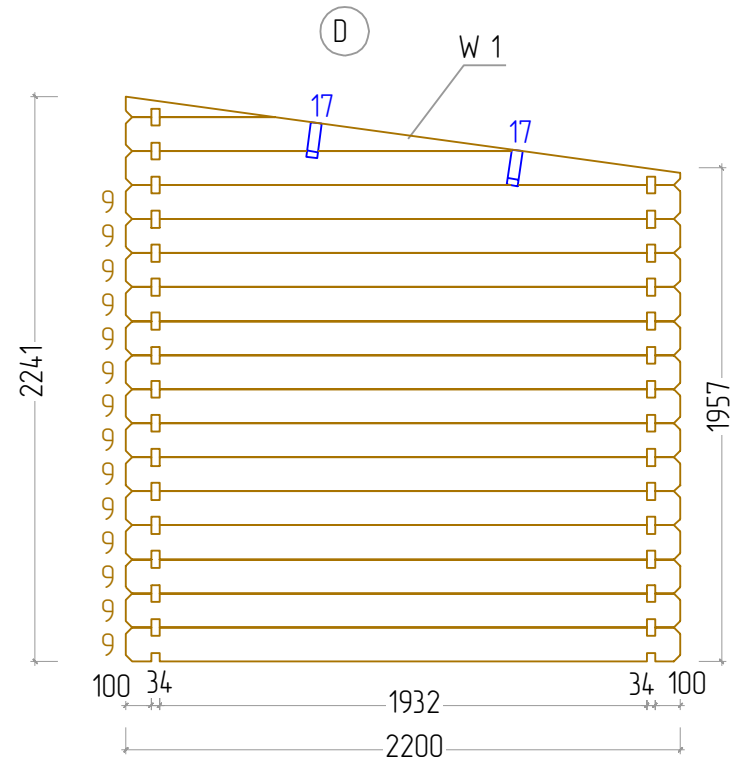
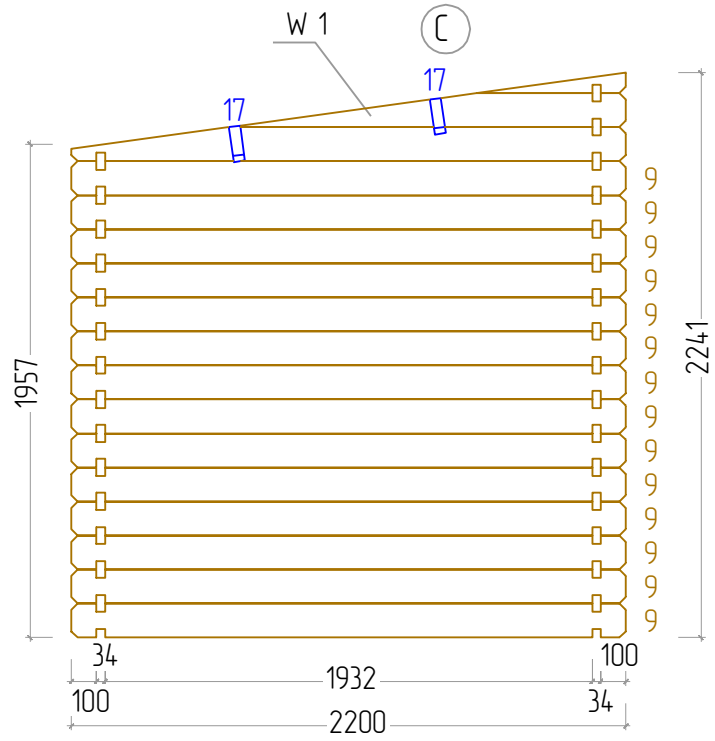

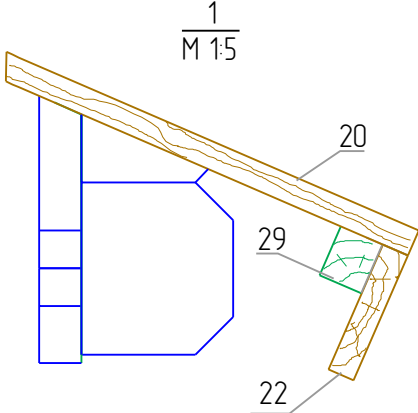
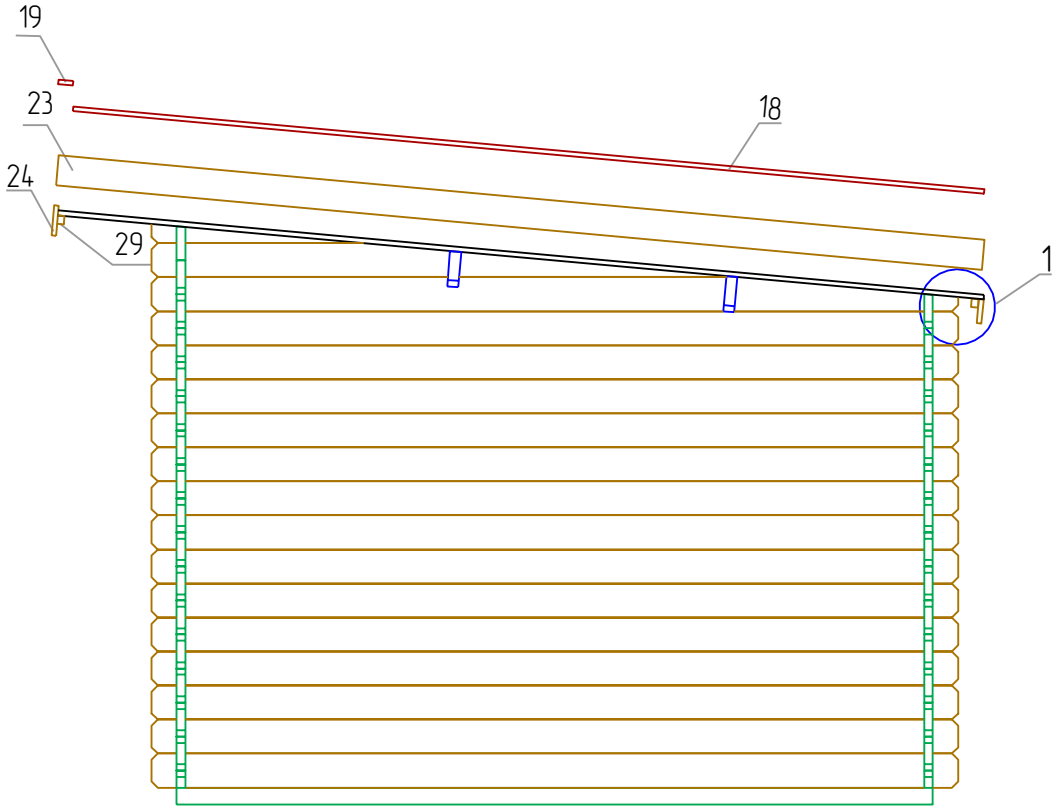

DK 34 4,2x2,2

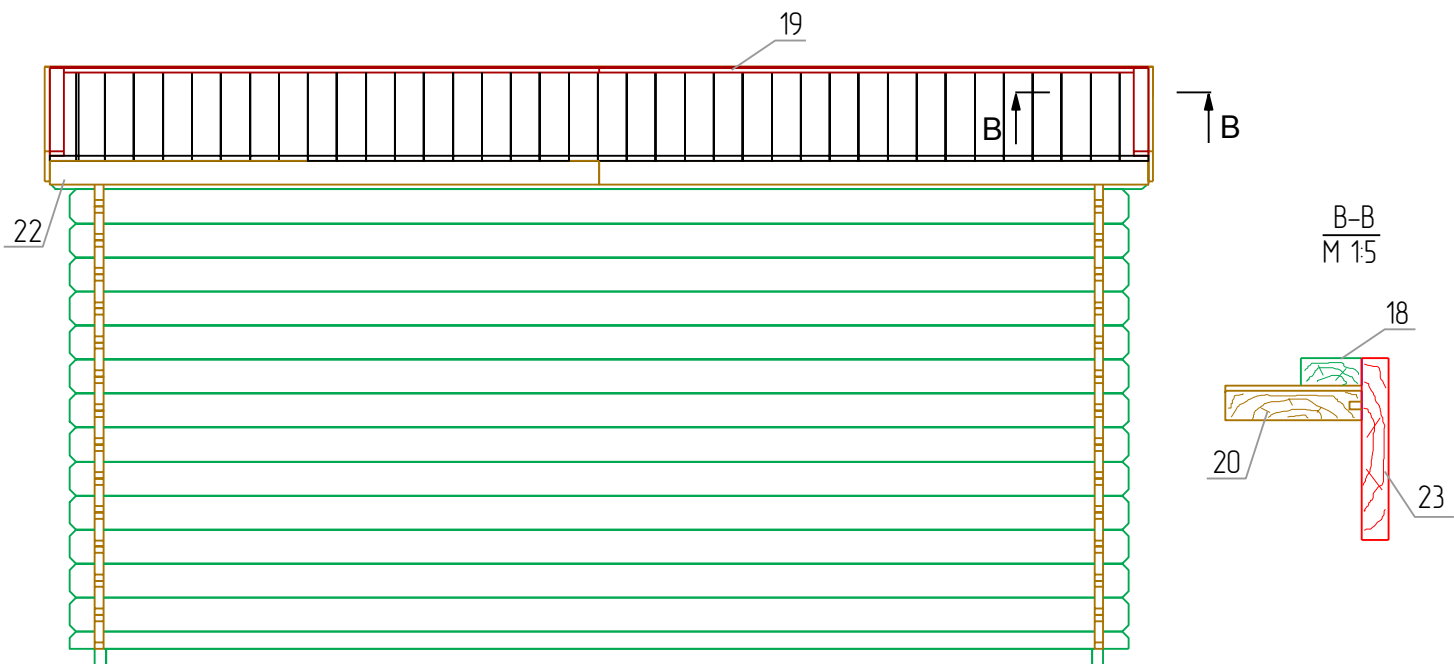

DK 34 4,2x2,2

Planimetria dei
travetti di partenza

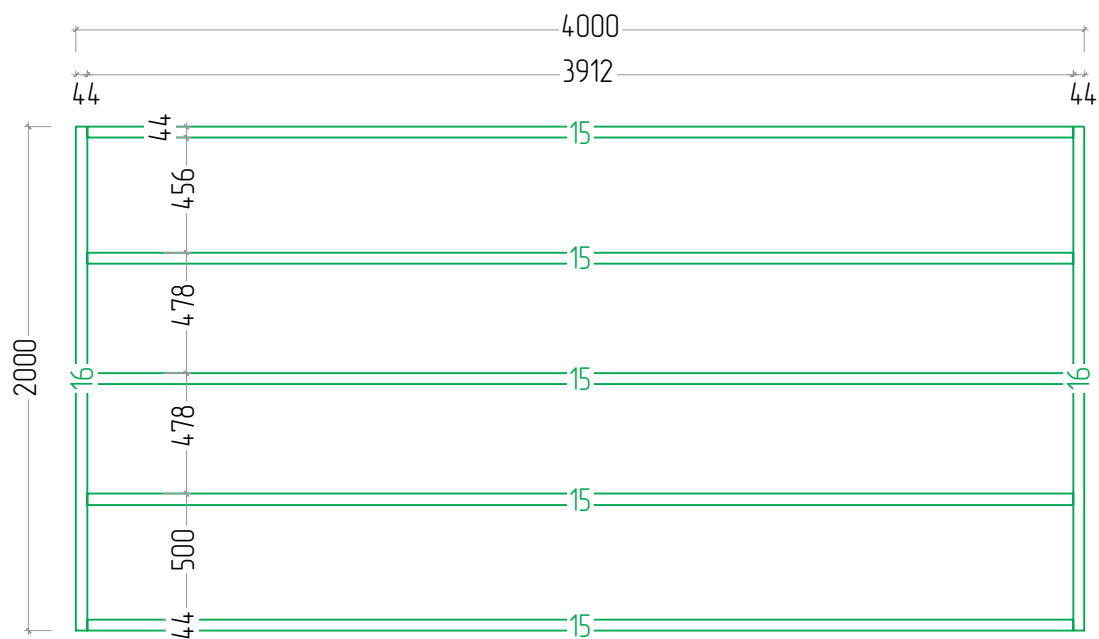

DK 34 4,2x2,2

Planimetria del pavimento

