

GH 34 3,2x4,2

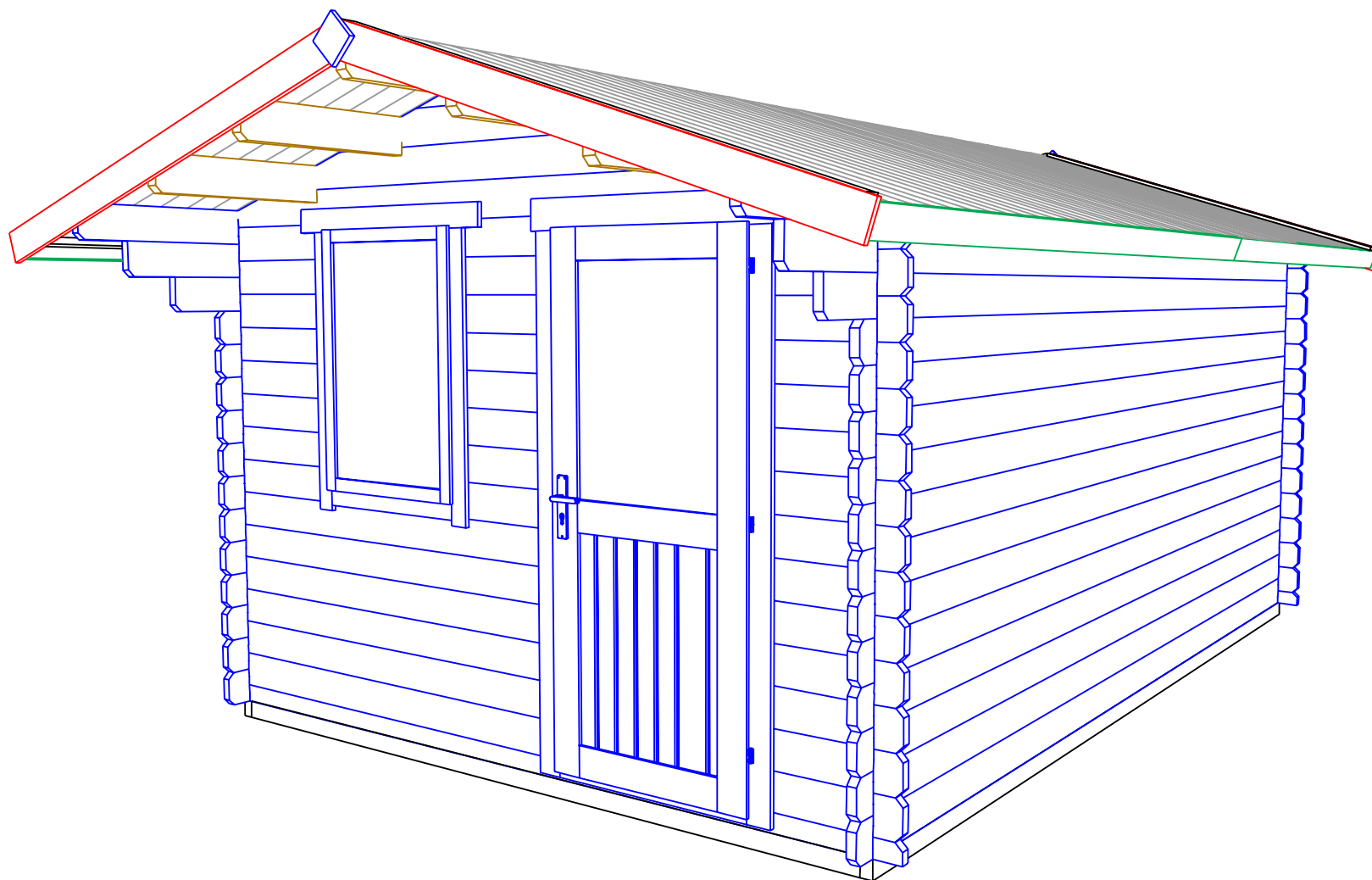

GH 34 3,2x4,2

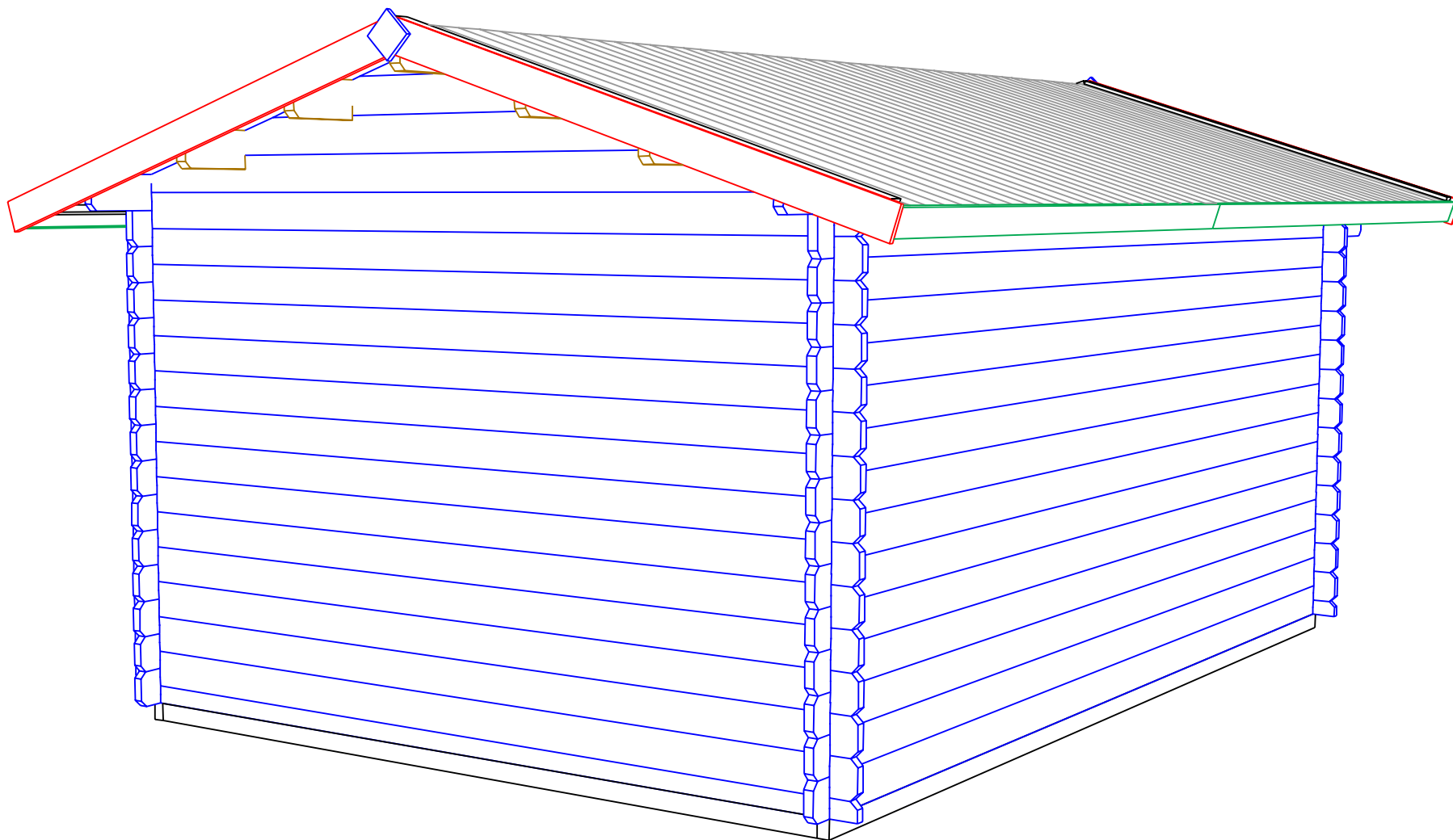

GH 34 3,2x4,2

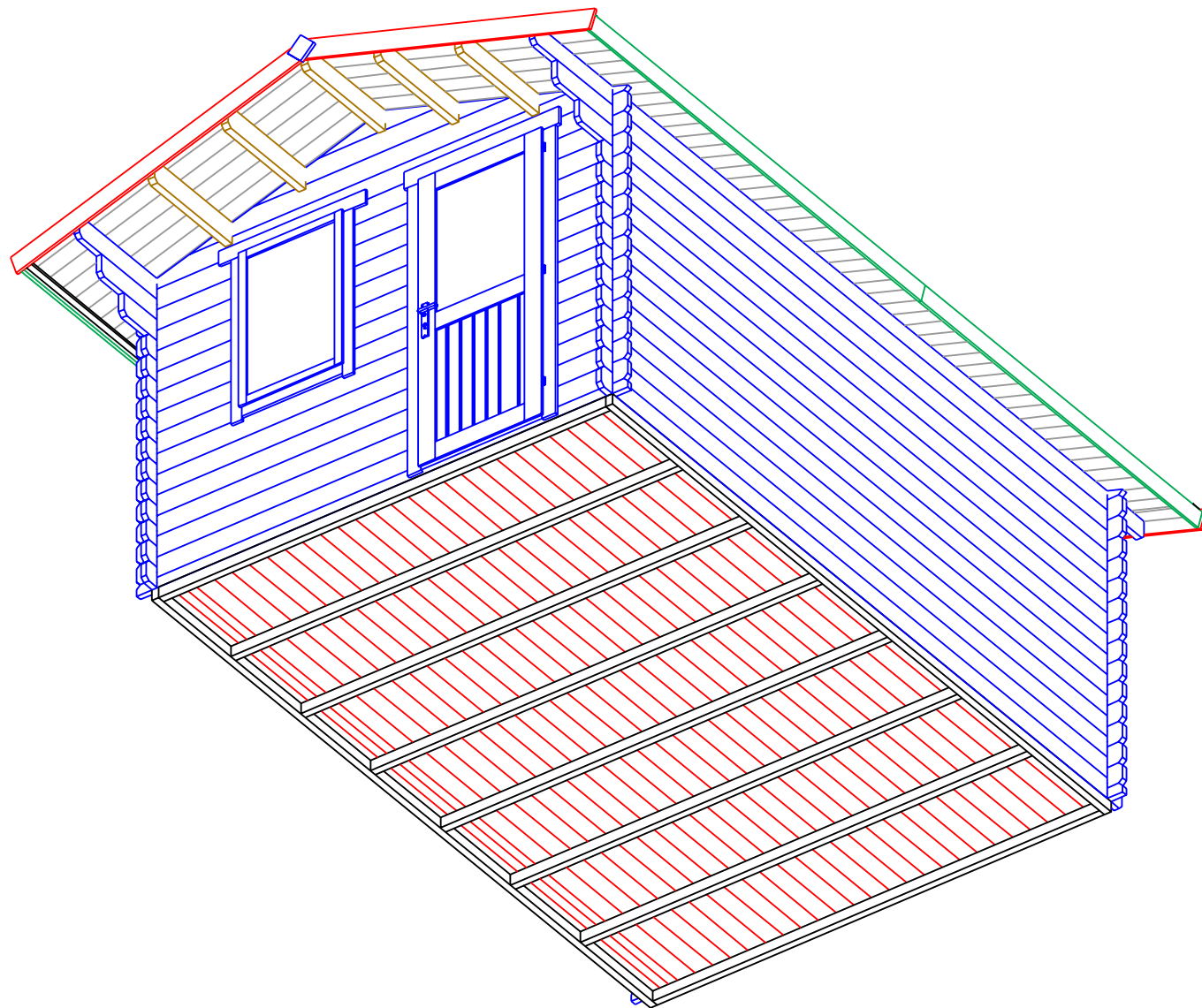

GH 34 3,2x4,2
Plan

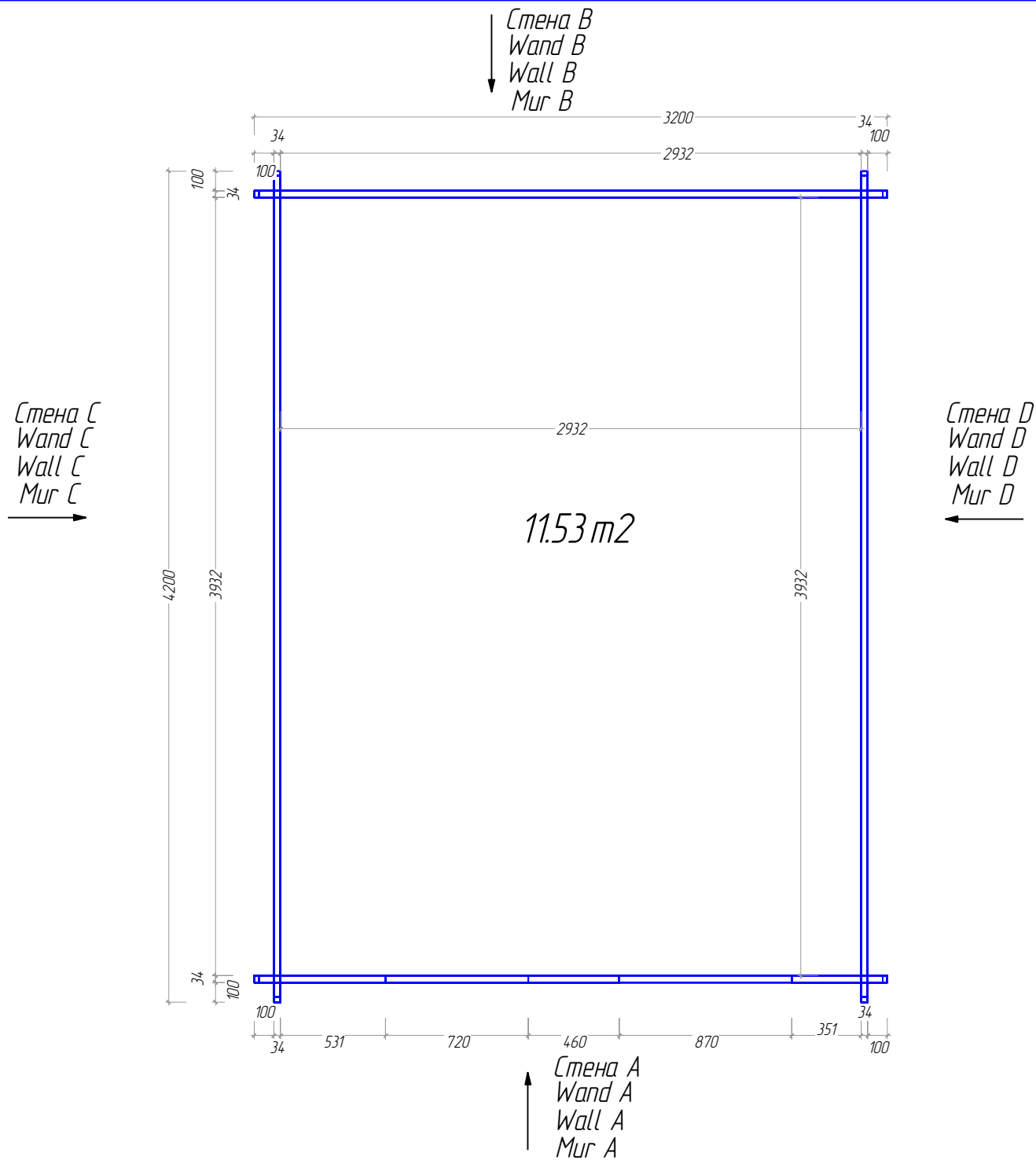

GH 34 3,2x4,2

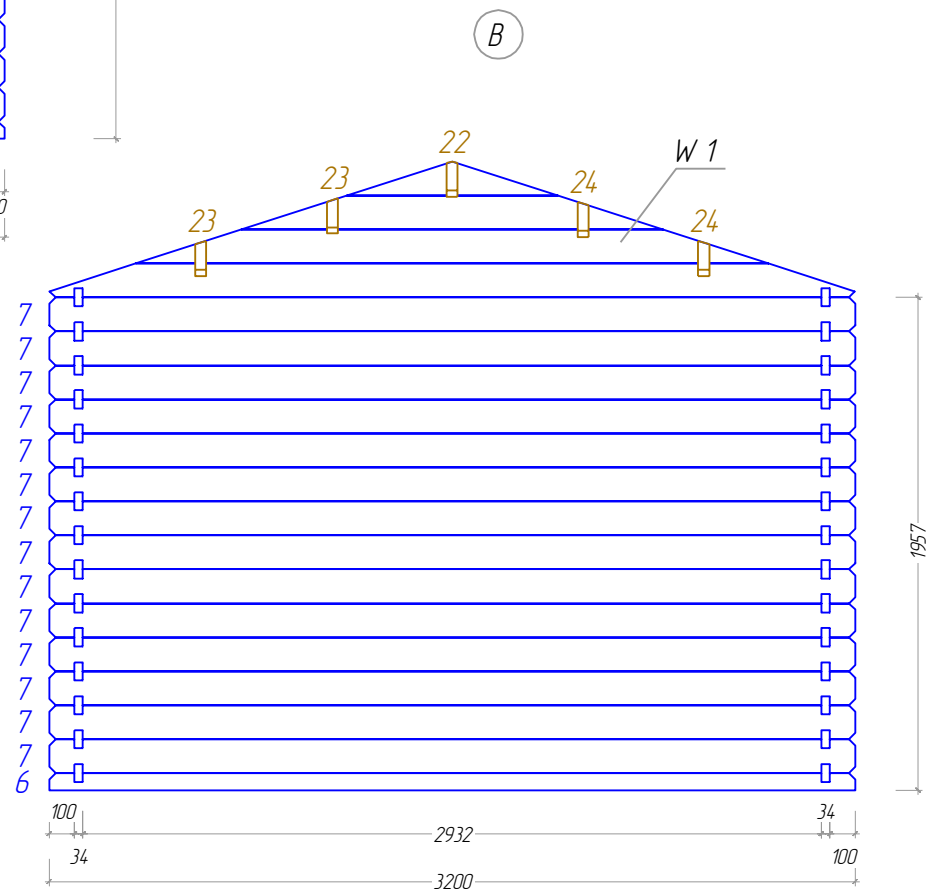
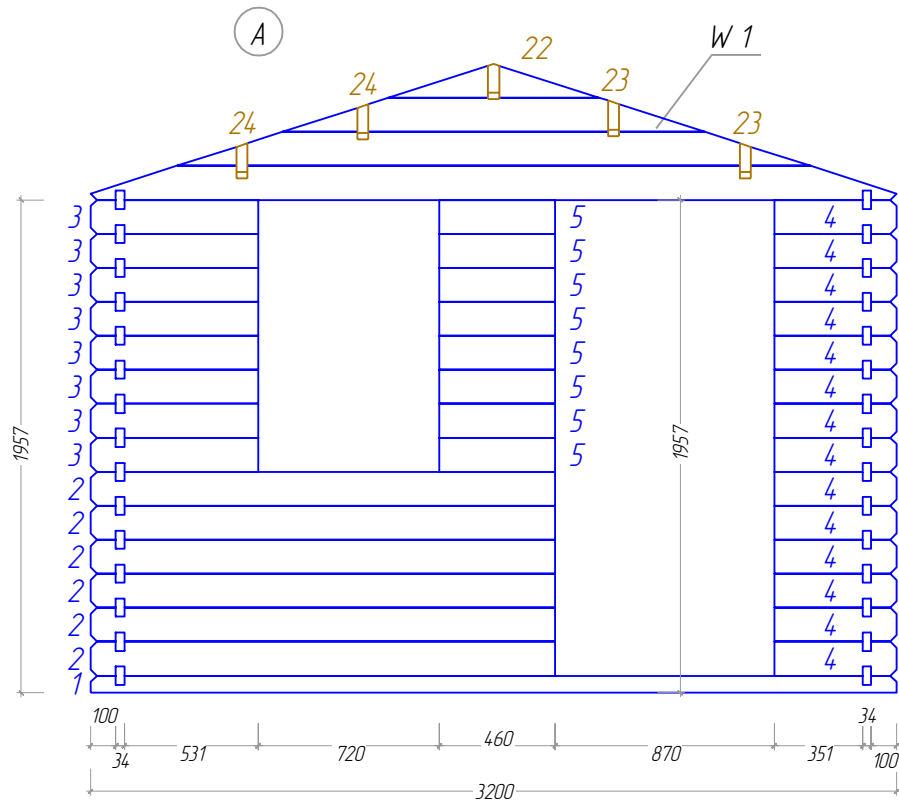

Ⓒ

GH 34 3,2x4,2

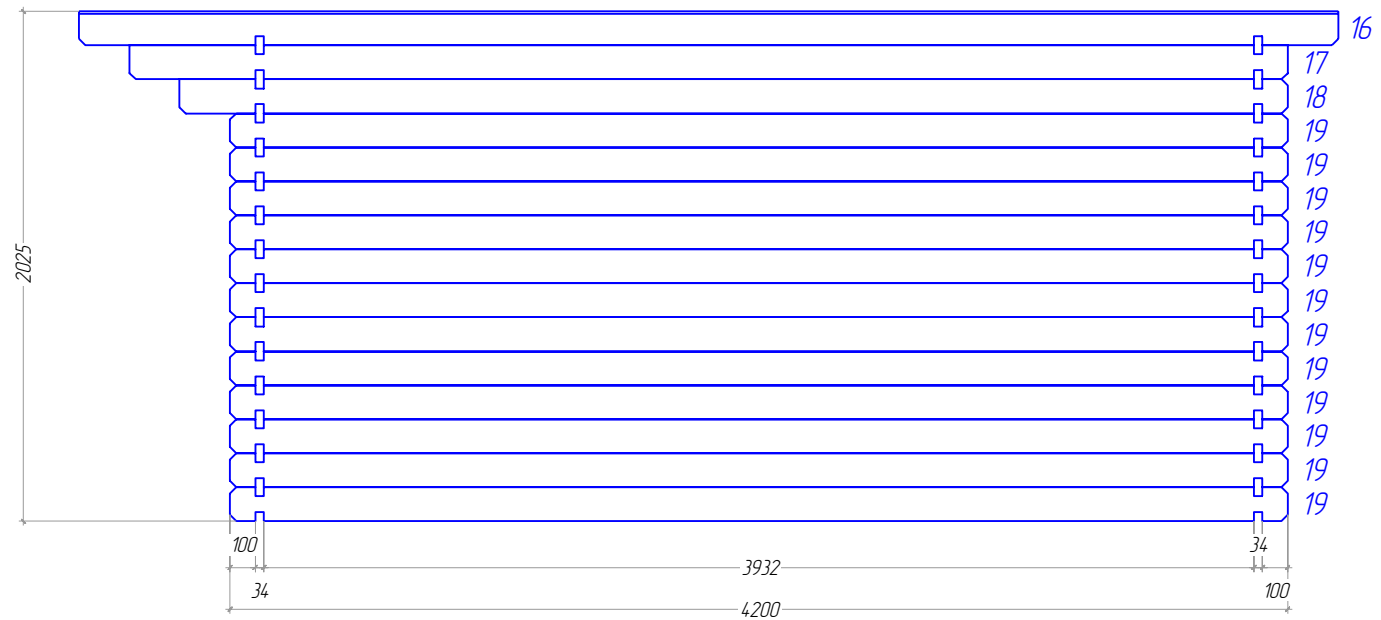
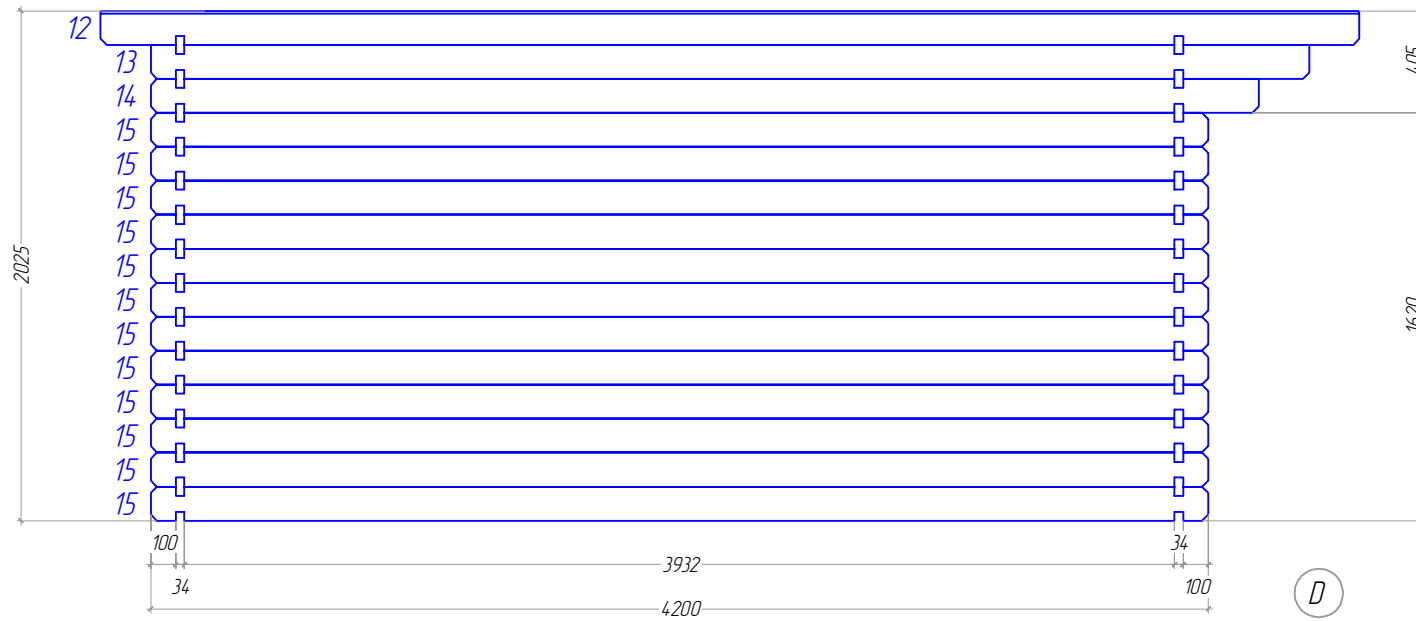

GH 34 3,2x4,2

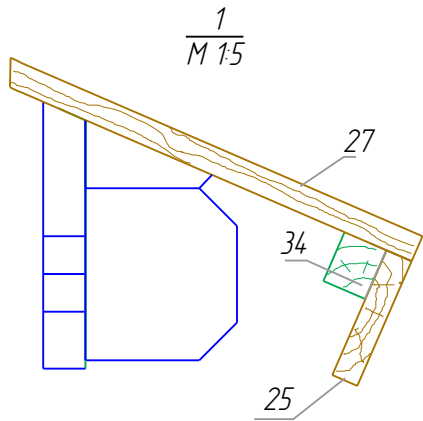
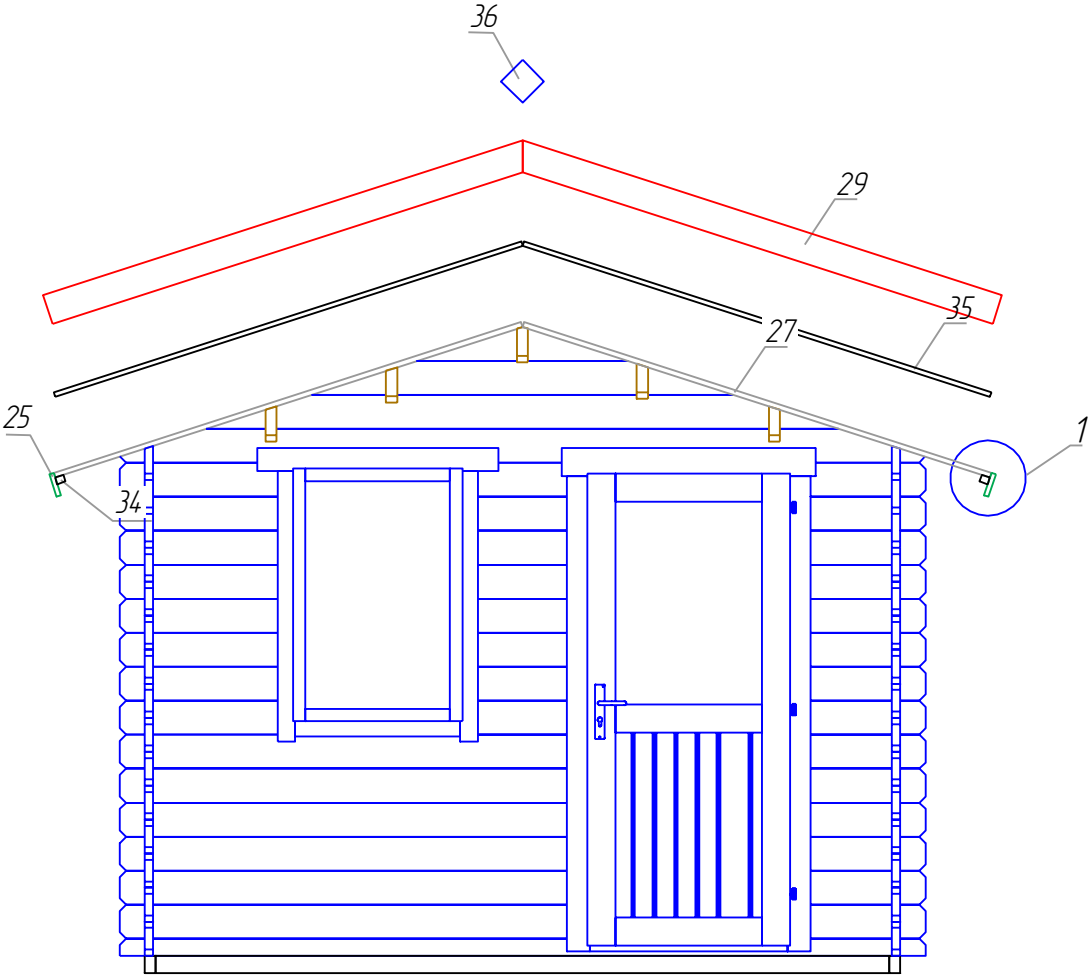

GH 34 3,2x4,2

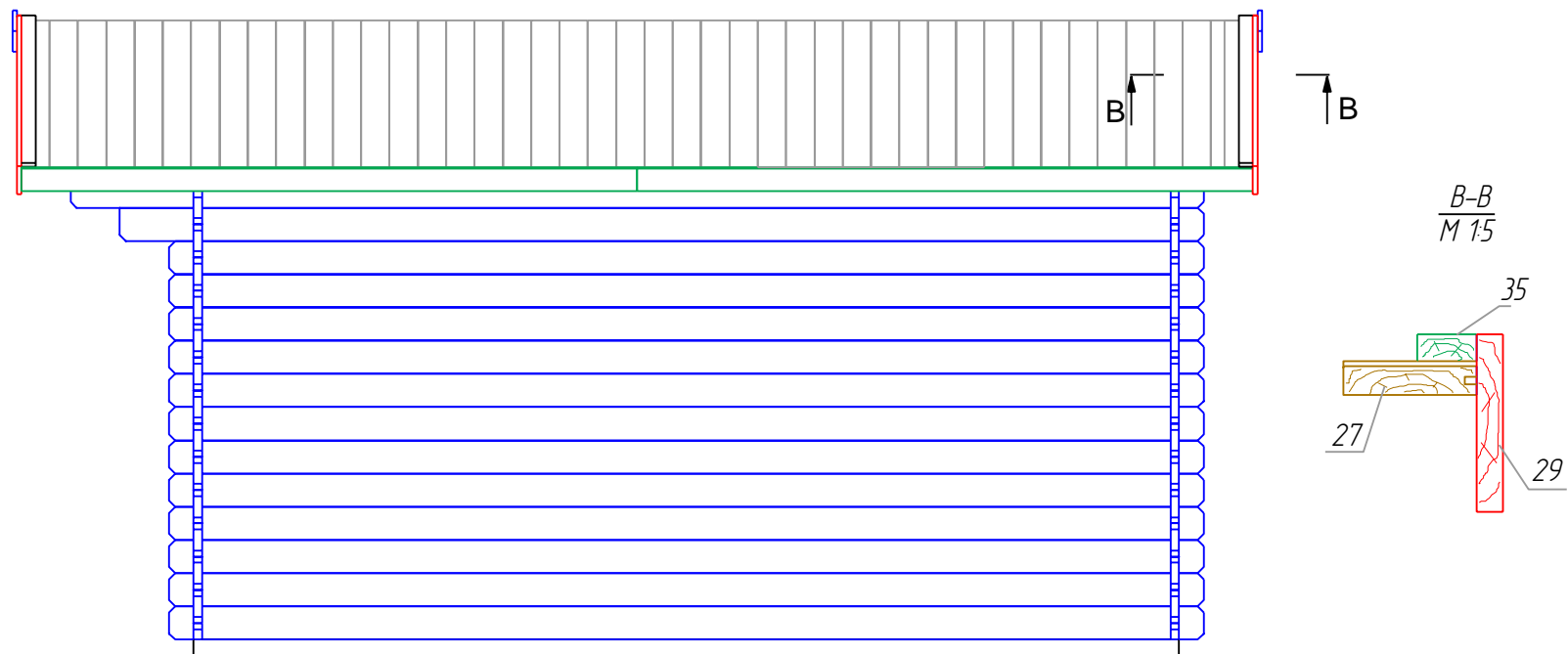

GH 34 3,2x4,2

Boarding joist plan

Trummplan

Lambourde plan

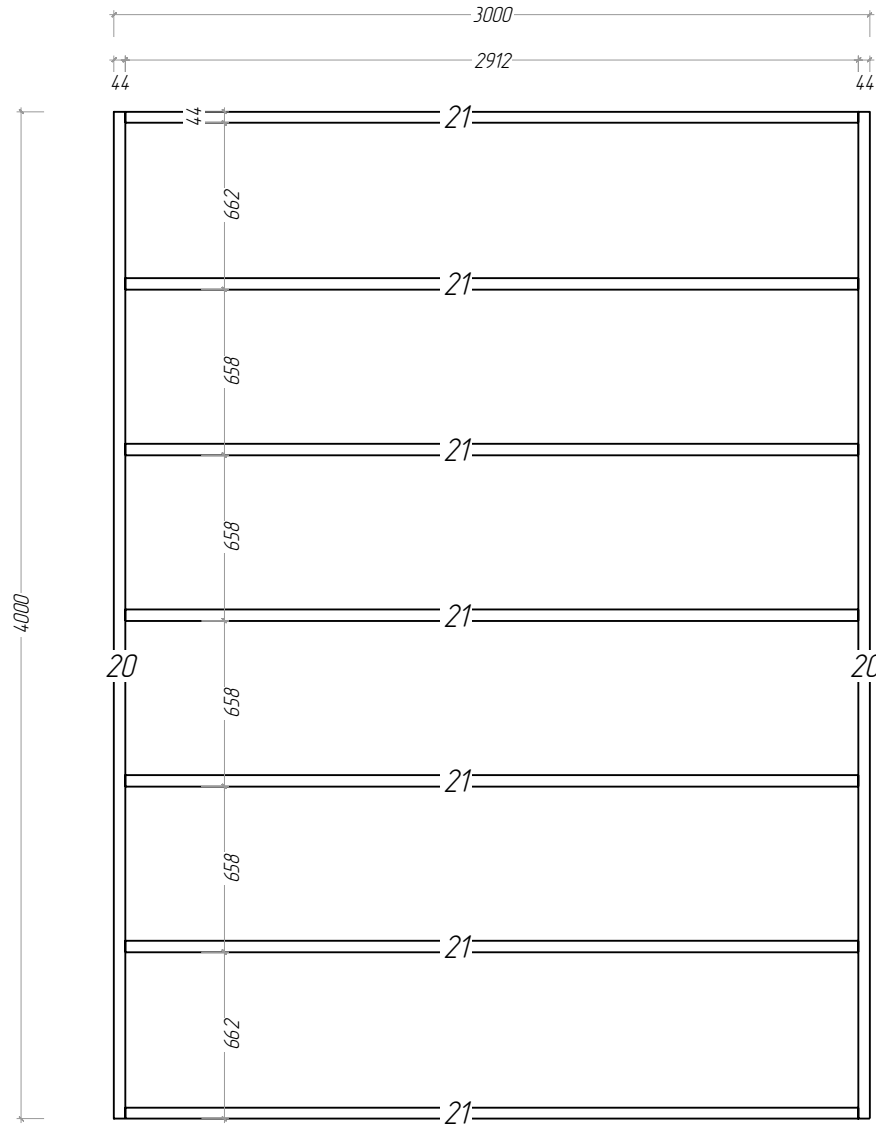



GH 34 3,2x4,2





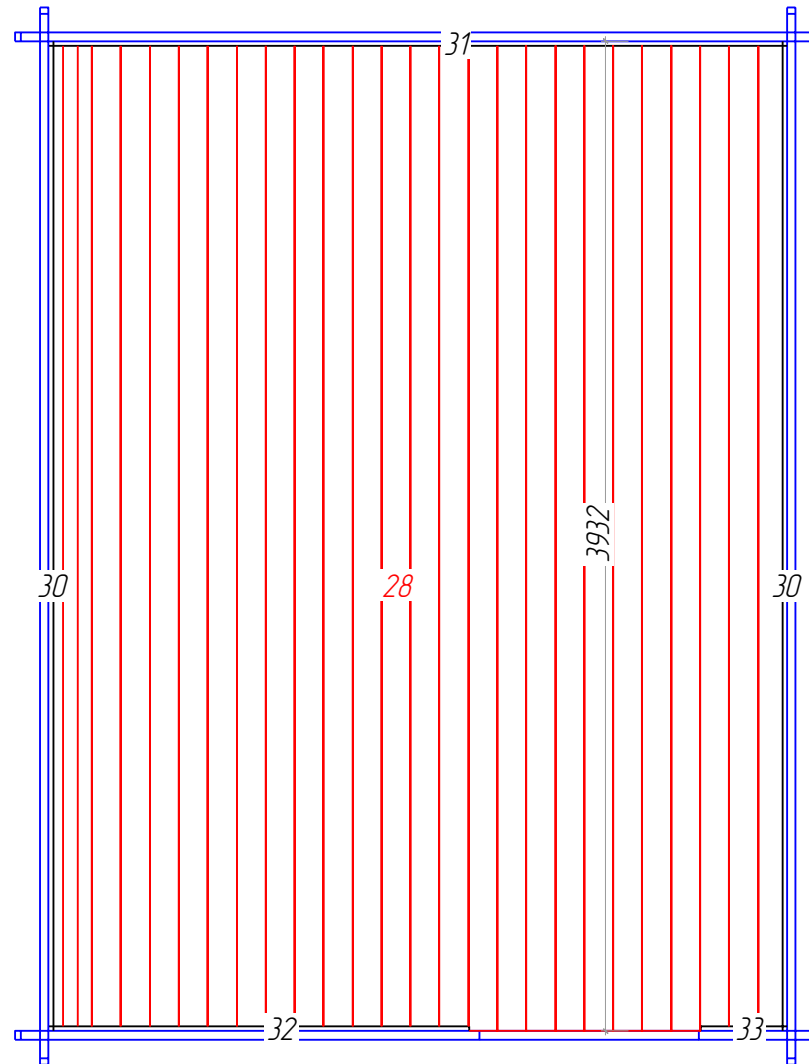

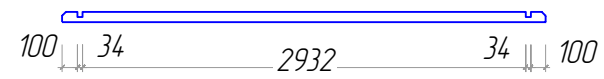
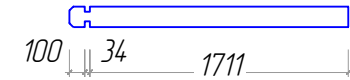
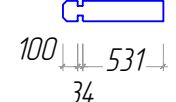

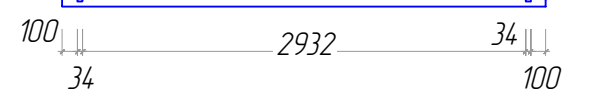
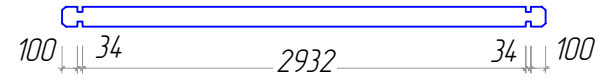
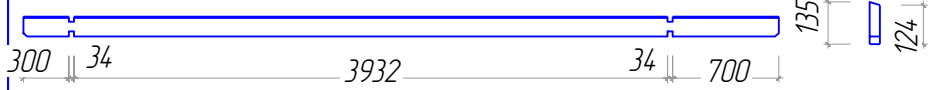
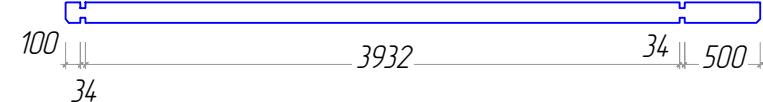
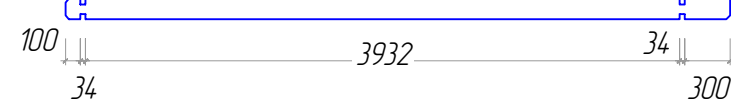
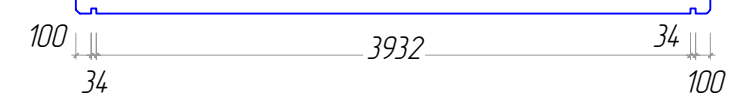
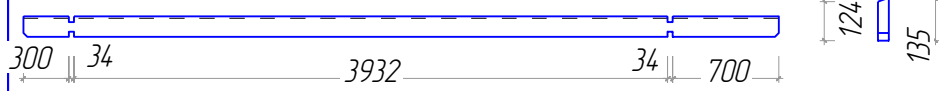
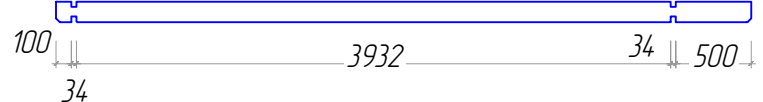

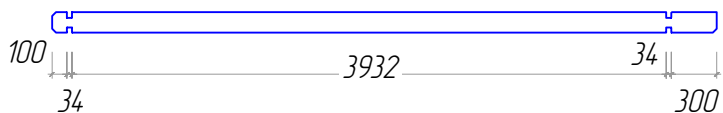
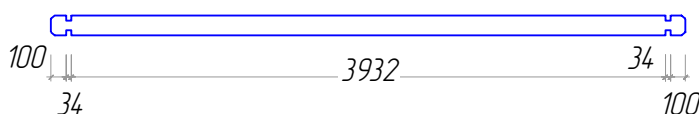
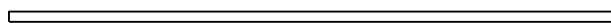
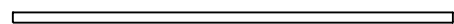
Plan of the floor board



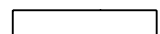

Plan der Furbodenbretter

Le plan des plaches du plancher



№	GH 34 3,2x4,2	№г.	Profile (mm)	Length (mm)
1	стены 	1	34x68	3200mm
2	стены 	6	34x135	1845mm
3	стены 	8	34x135	665mm
4	стены 	14	34x135	485mm
5	стены 	8	34x135	460mm
6	стены 	1	34x68	3200mm
7	стены 	14	34x135	3200mm
12	стены 	1	34x135	5000mm
13	стены 	1	34x135	4600mm
14	стены 	1	34x135	4400mm
15	стены 	12+1	34x135	4200mm
16	стены 	1	34x135	5000mm
17	стены 	1	34x135	4600mm

№	GH 34 3,2x4,2	№.	Profile (mm)	Length (mm)
18	<p>стены</p> 	1	34x135	4400mm
19	<p>стены</p> 	12	34x135	4200mm
20	<p>лага Foundation Fundament Solive</p> 	2	44x68	4000mm
21	<p>лага Foundation Fundament Solive</p> 	7	44x68	2912mm
22	<p>прогон Roof beam. Dachbalken. Panne</p> 	1	44x140	5000mm
23	<p>прогон Roof beam. Dachbalken. Panne</p> 	2	44x140	5000mm
24	<p>прогон Roof beam. Dachbalken. Panne</p> 	2	44x140	5000mm
25	<p>ветровая доска Roofing felt fillet Giebelabschlussbrett Latte de finition couverture</p> 	4	18x95	2500mm
27	<p>доска крыши Roof boards Dachbretter Volige</p> 	88+1	20x115	1950mm
28	<p>Доска пола Floor boards Fu ssboden Lame de plancher</p> 	26+1	20x115	3930mm
29	<p>ладовая Fascia board Giebelblende Planch de rive facade</p> 	4	18x120	2000mm
30	<p>плинтус Floor edge trim Fu bleisten Plinthe plancher</p> 	2	18x20	3932mm
31	<p>плинтус Floor edge trim Fu bleisten Plinthe plancher</p> 	1	18x20	2932mm

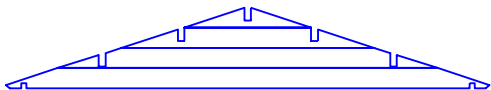
№	GH 34 3,2x4,2	Nr.	Profile (mm)	Lenght (mm)
32	<p>плинтус Floor edge trim Fu bleisten Plinthe plancher</p> 	1	18x20	1671mm
33	<p>плинтус Floor edge trim Fu bleisten Plinthe plancher</p> 	1	18x20	341mm
34	<p>плинтус к свесу Roof edge reinforcement Traufenteisteu Tasseau</p> 	4	28x34m	2500mm
35	<p>прижимная доска</p> 	4	18x58	1950mm
36	<p>Диамант</p> 	2	18x120m	120mm
	<p>Door 1958x870 мм Tur La porte</p>	1		
	<p>Windows 1080x720 мм</p>	1		
W-1		2		