

GH 34 2,7x2,2

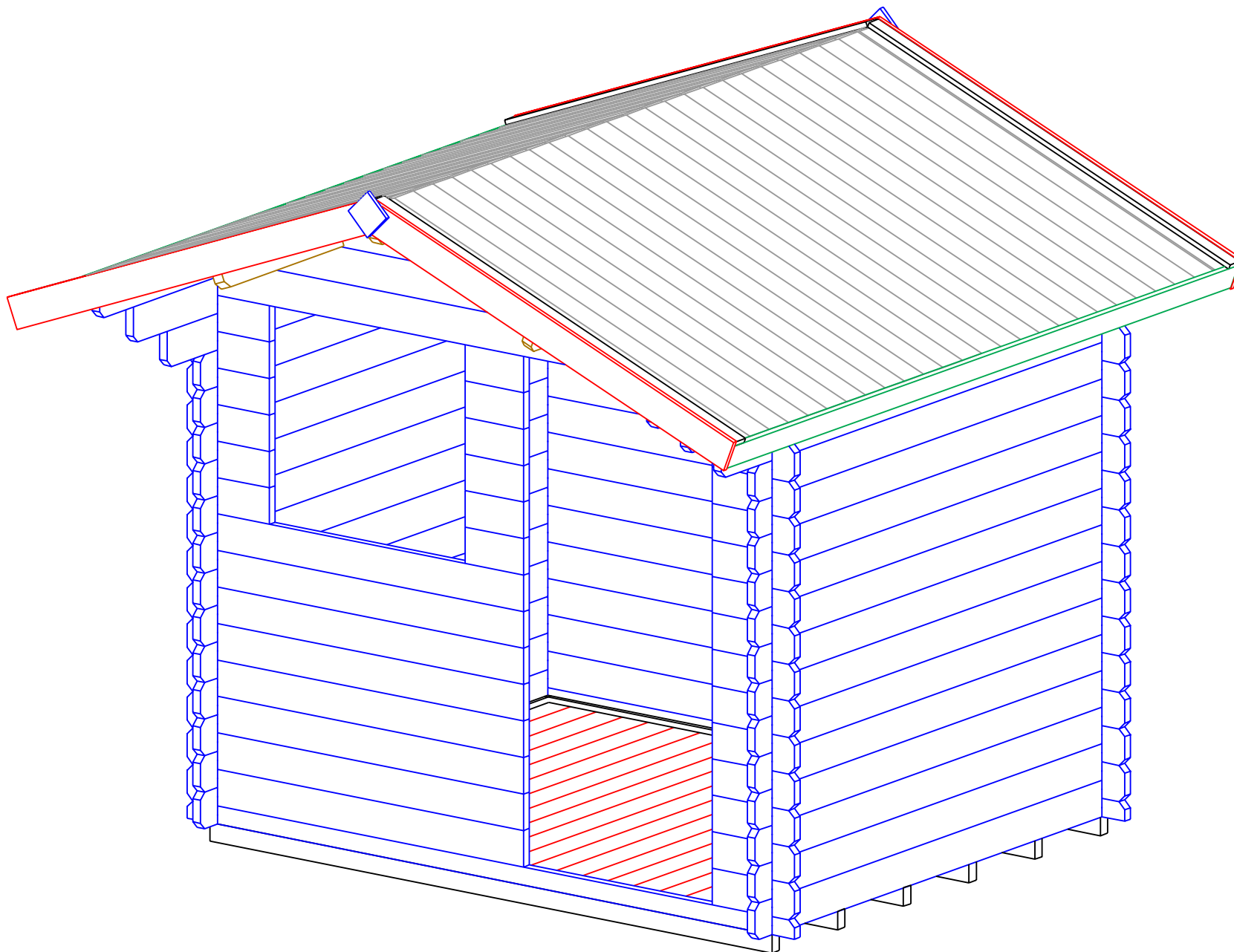

GH 34 2,7x2,2

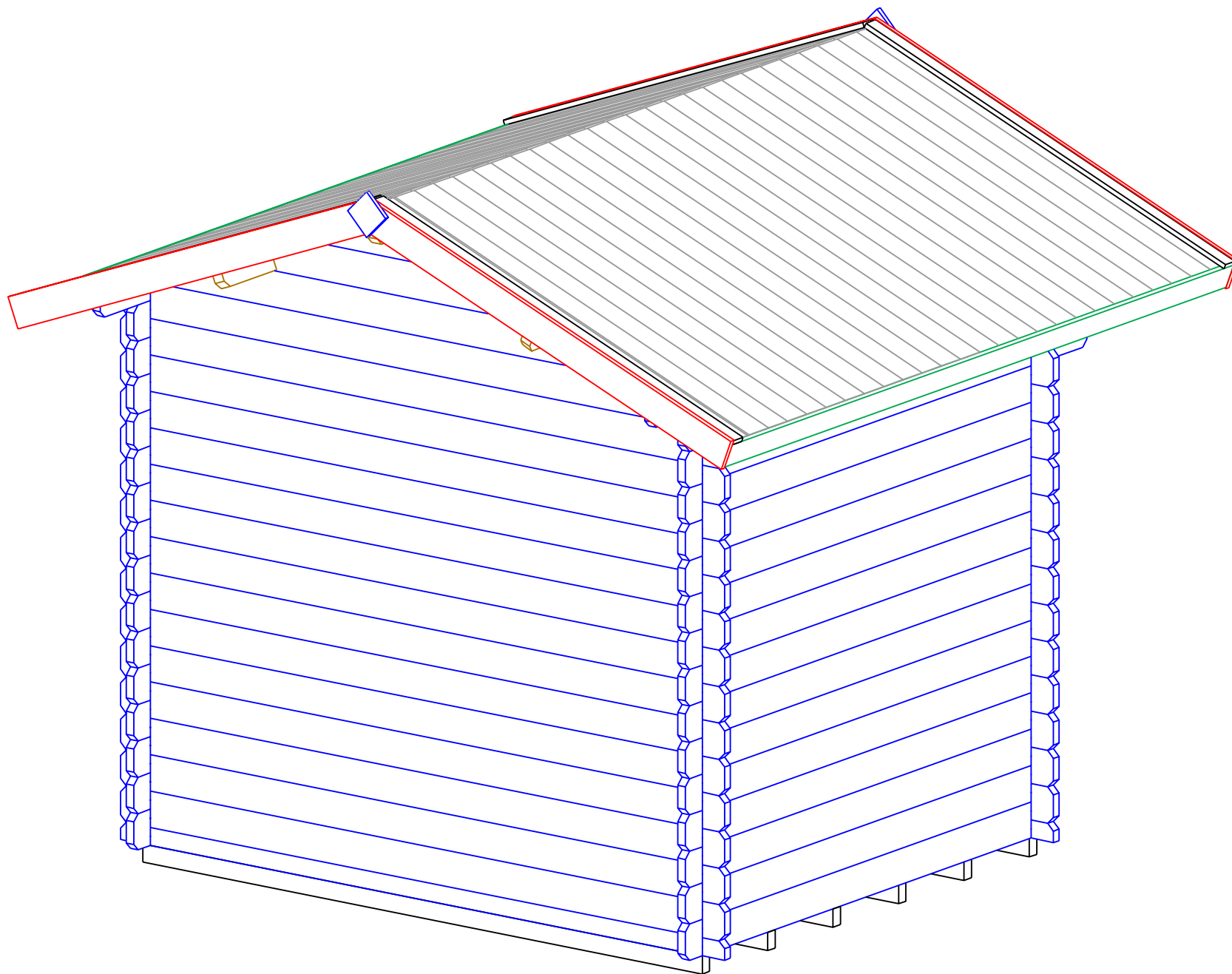

GH 34 2,7x2,2

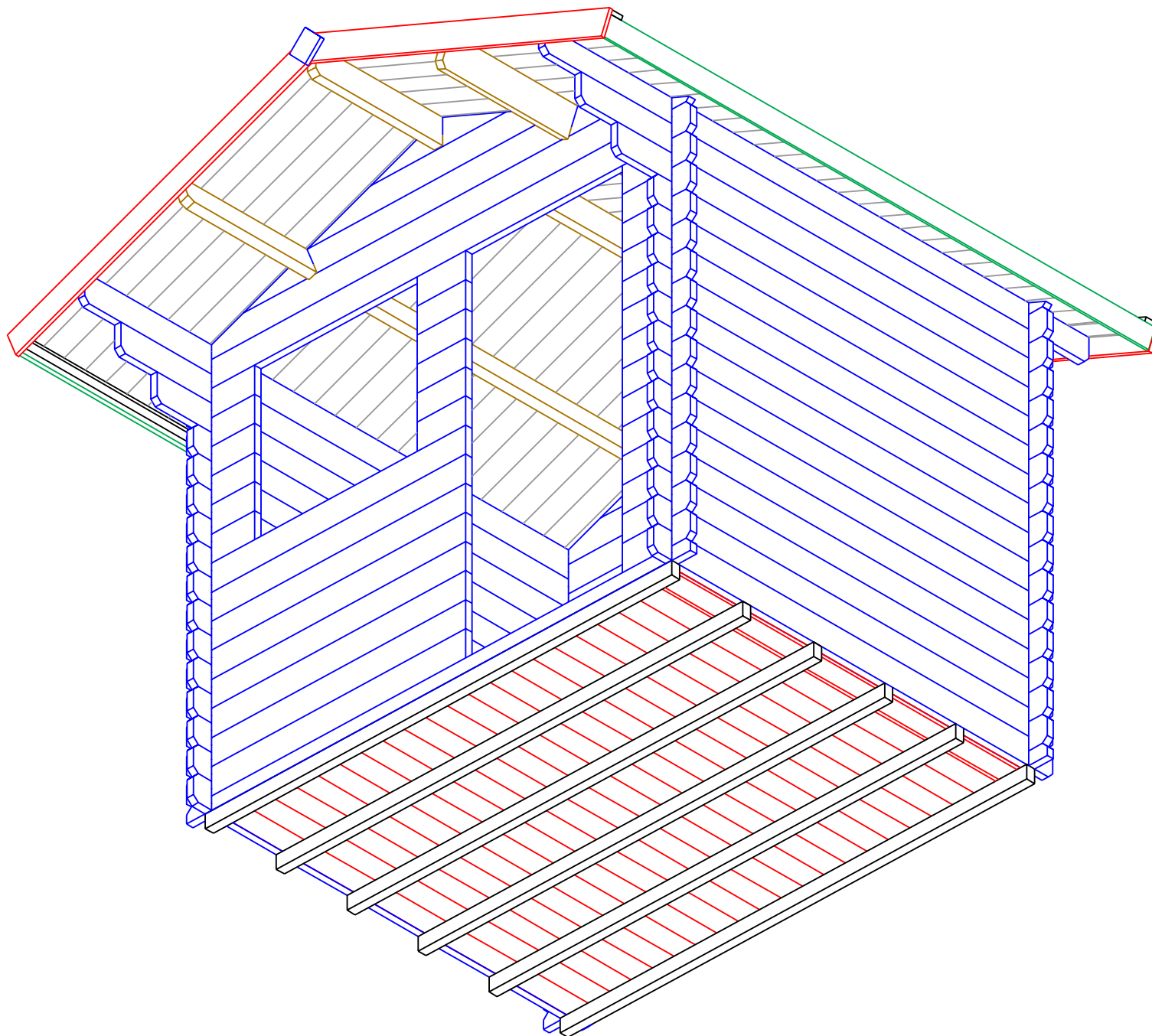

GH 34 2,7x2,2

Plan

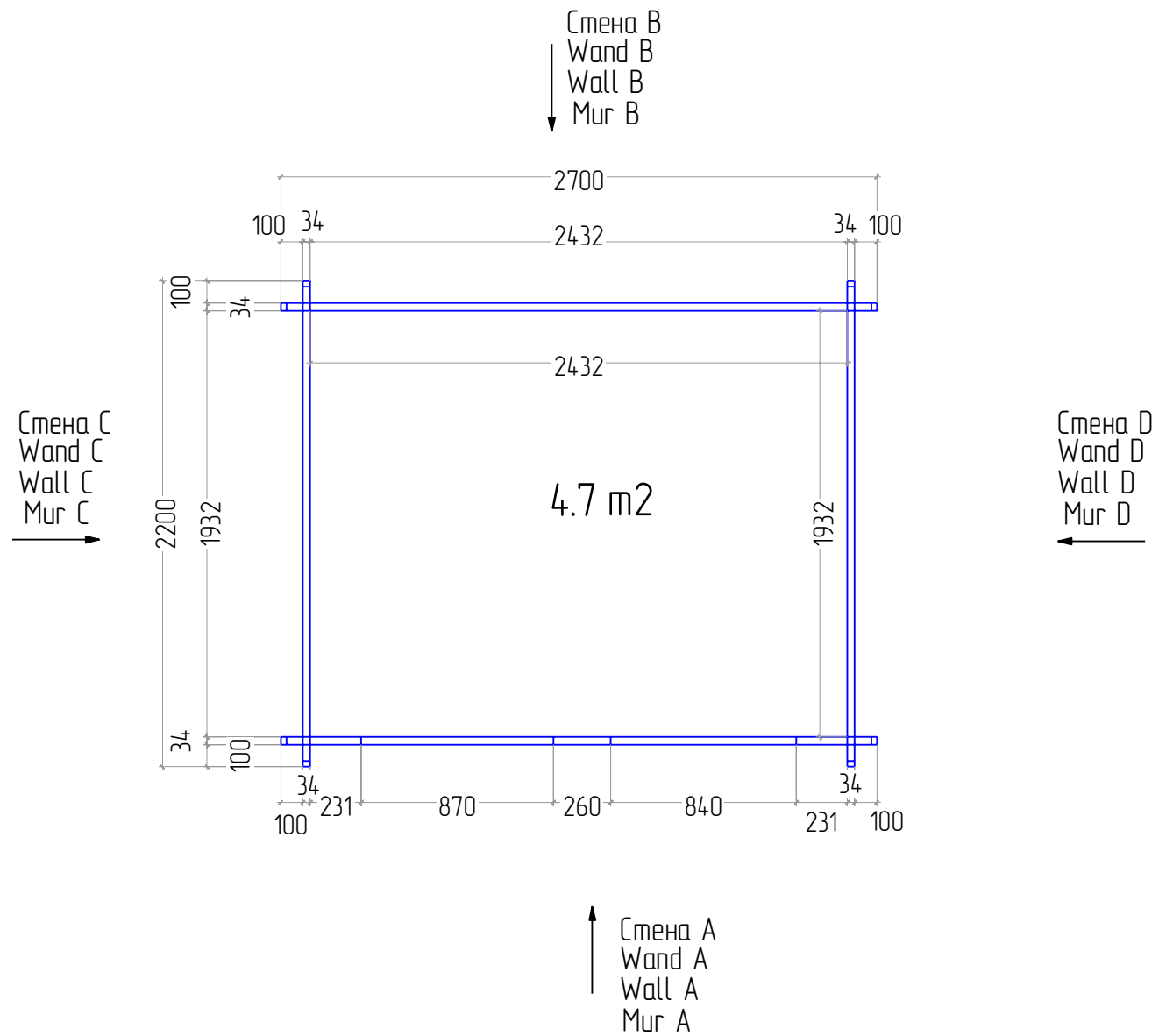

GH 34 2,7x2,2

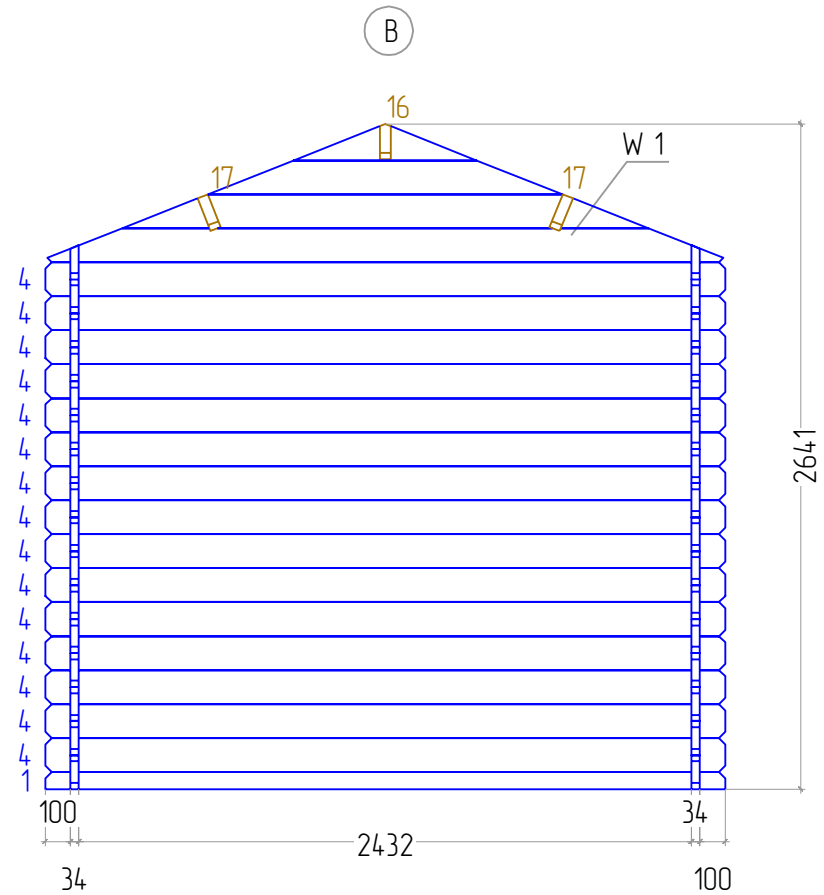
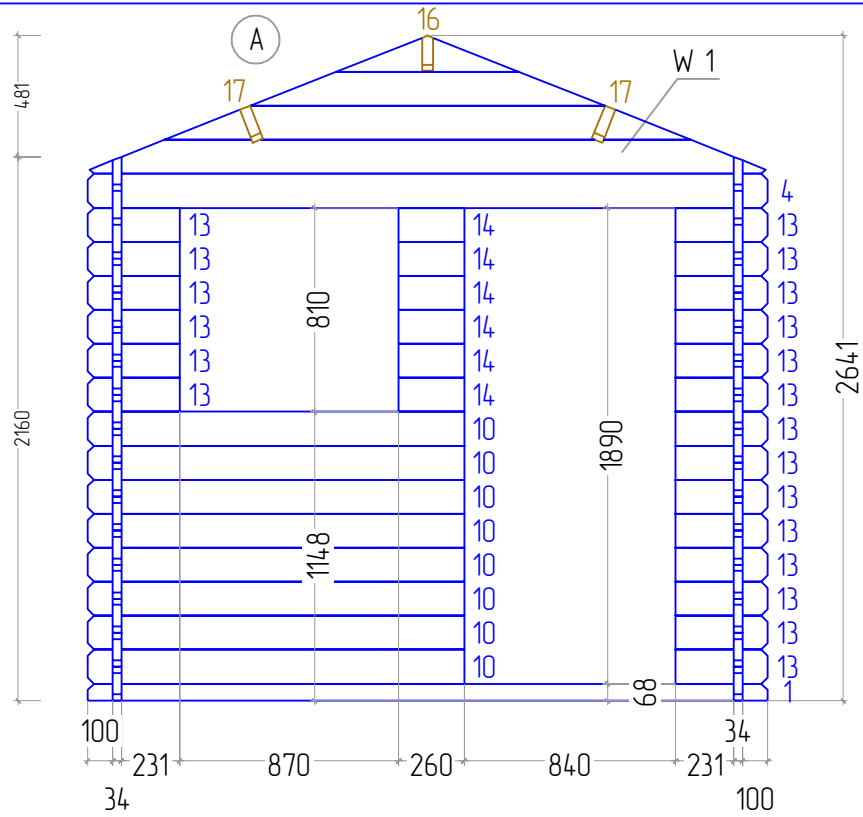



GH 34 2,7x2,2

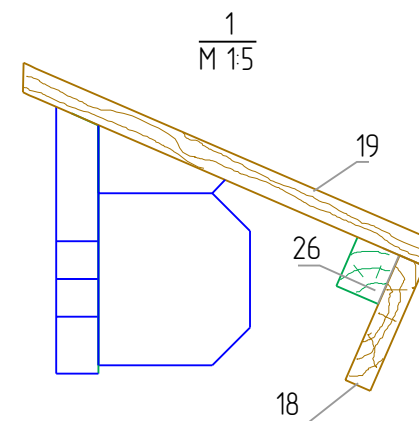
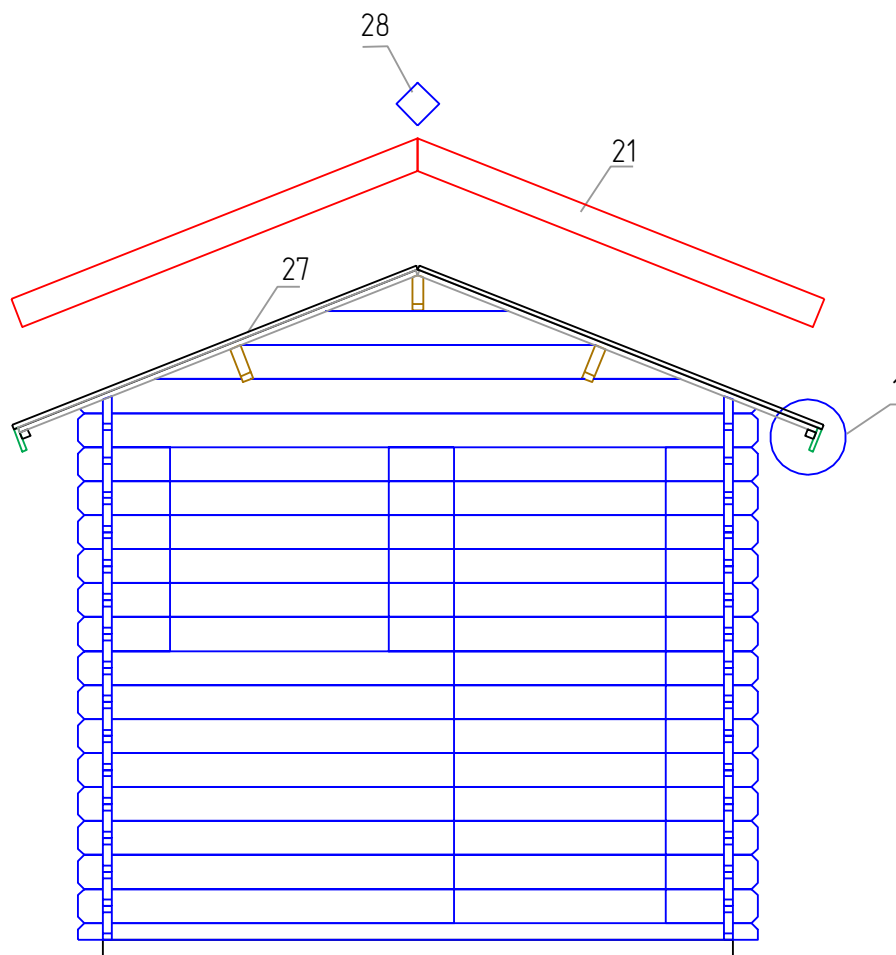

GH 34 2,7x2,2

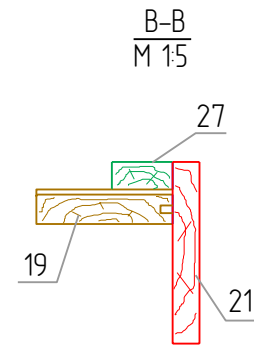
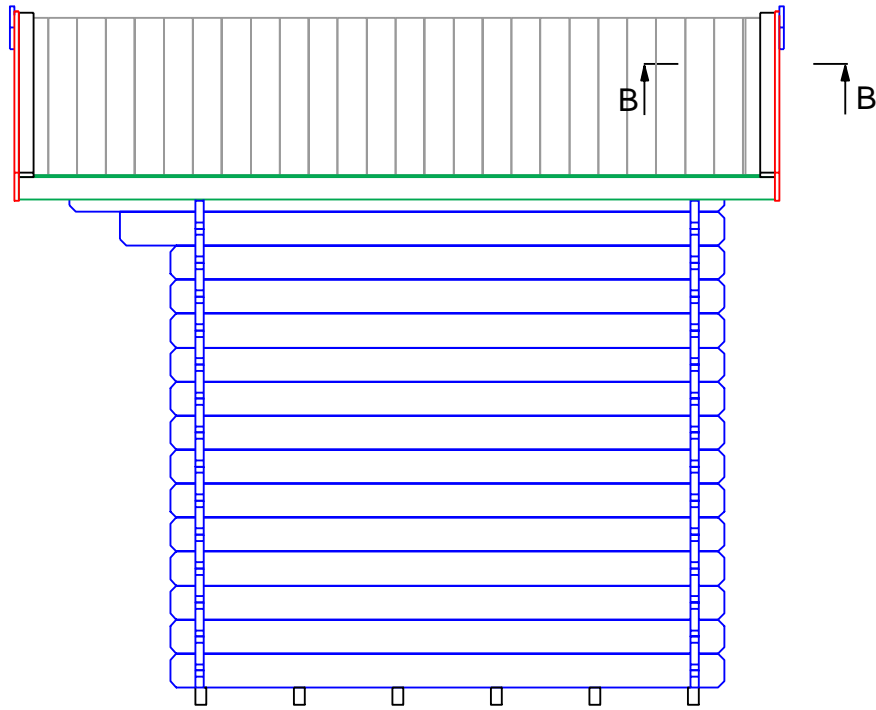



# GH 34 2,7x2,2

Boarding joist plan

Trummpfan



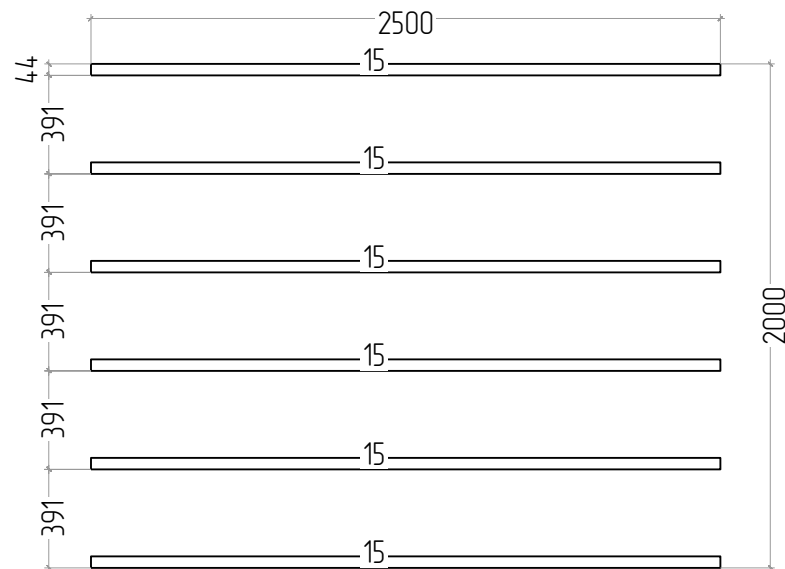

Lambourde plan



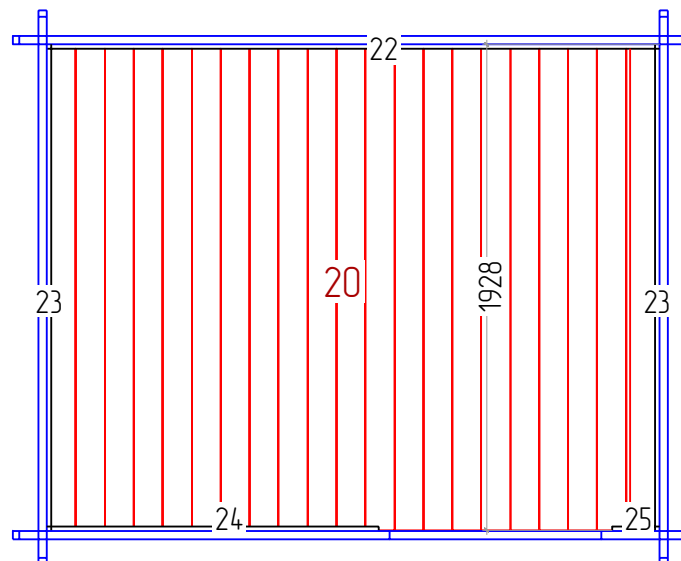

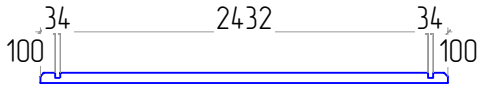
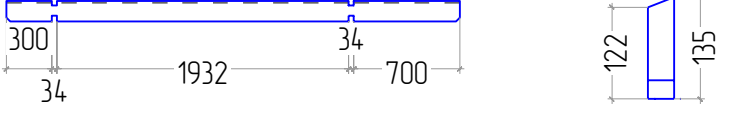
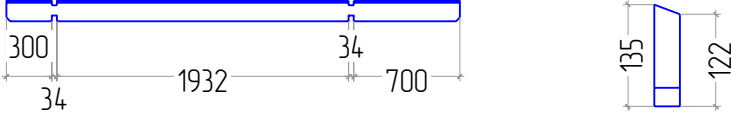
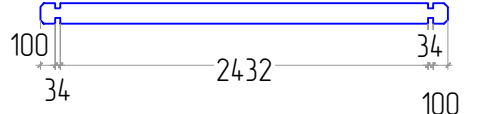
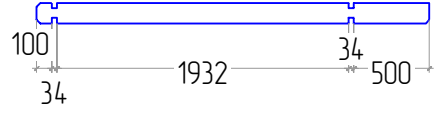
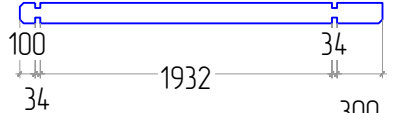
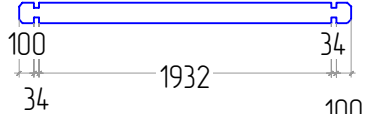

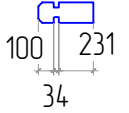

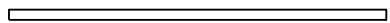
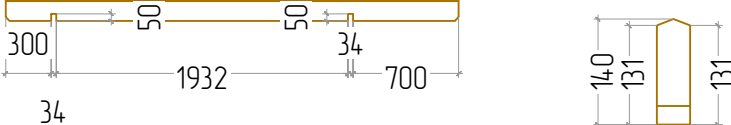
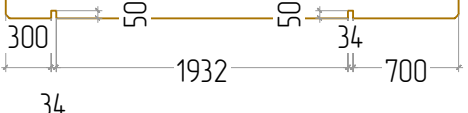



GH 34 2,7x2,2

Plan of the floor board  
Plan der Furbodenbretter  
Le plan des plaches du plancher

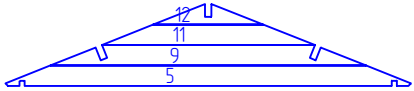

№	GH 34 2,7x2,2	№r.	Profile (mm)	Lenght (mm)
1	стены 	2	34x67.5	2700mm
2	стены 	1	34x135	3000mm
3	стены 	1	34x135	3000mm
4	стены 	16	34x135	2700mm
6	стены 	2	34x135	2600mm
7	стены 	2	34x135	2400mm
8	стены 	26	34x135	2200mm
10	стены 	8	34x135	14,95mm
13	стены 	20	34x135	365mm
14	стены 	6	34x135	260mm
15	лага Foundation Fundament Solive 	6	44x68	2500mm
16		1	44x140	3000mm
17		2	44x140	3000mm

№	GH 34 2,7x2,2	№.	Profile (mm)	Lenght (mm)
18	ветровая доска Roofing felt fillet Giebelabschlussbrett Latte de finition couverture 	2	18x95	3000mm
19	доска крыши Roof boards Dachbretter Volige 	54	20x115	1700mm
20	Доска пола Floor boards Fu ssboden Lame de plancher 	20	20x115	1928mm
21	лобовая Fascia board Giebelblende Planch de rive facade 	4	18x120	2000mm
22	плинтус Floor edge trim Fu bleisten Plinthe plancher 	1	18x20	2432mm
23	плинтус Floor edge trim Fu bleisten Plinthe plancher 	2	18x20	1932mm
24	плинтус Floor edge trim Fu bleisten Plinthe plancher 	1	18x20	1318mm
25	плинтус Floor edge trim Fu bleisten Plinthe plancher 	1	18x20	188mm
26	плинтус к свесу Roof edge reinforcement Traufenteisteu Tasseau 	2	28x34m	3000mm
27	прижимная доска 	4	18x58	1726mm
28	Диамант 	2	18x120	120mm
W-1		2		