

DK 34 4,2x4,2

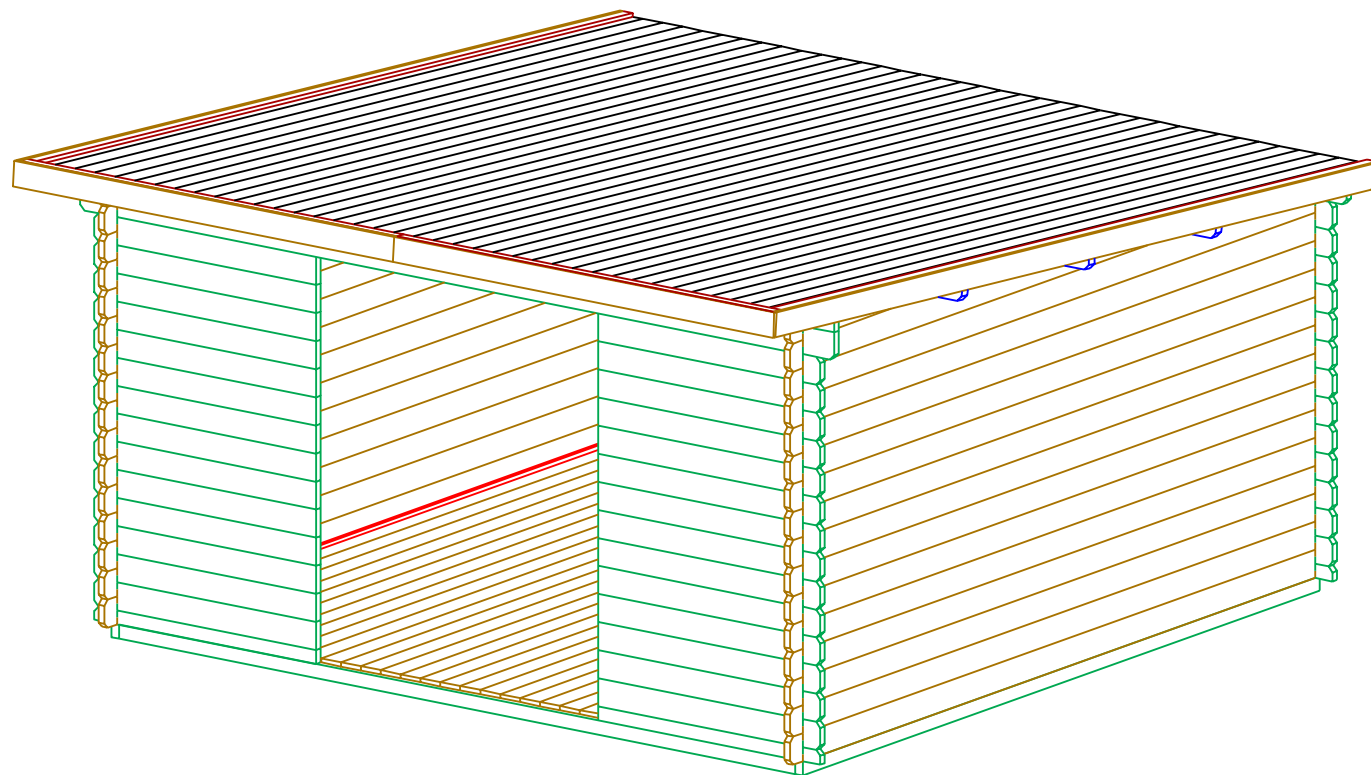

DK 34 4,2x4,2

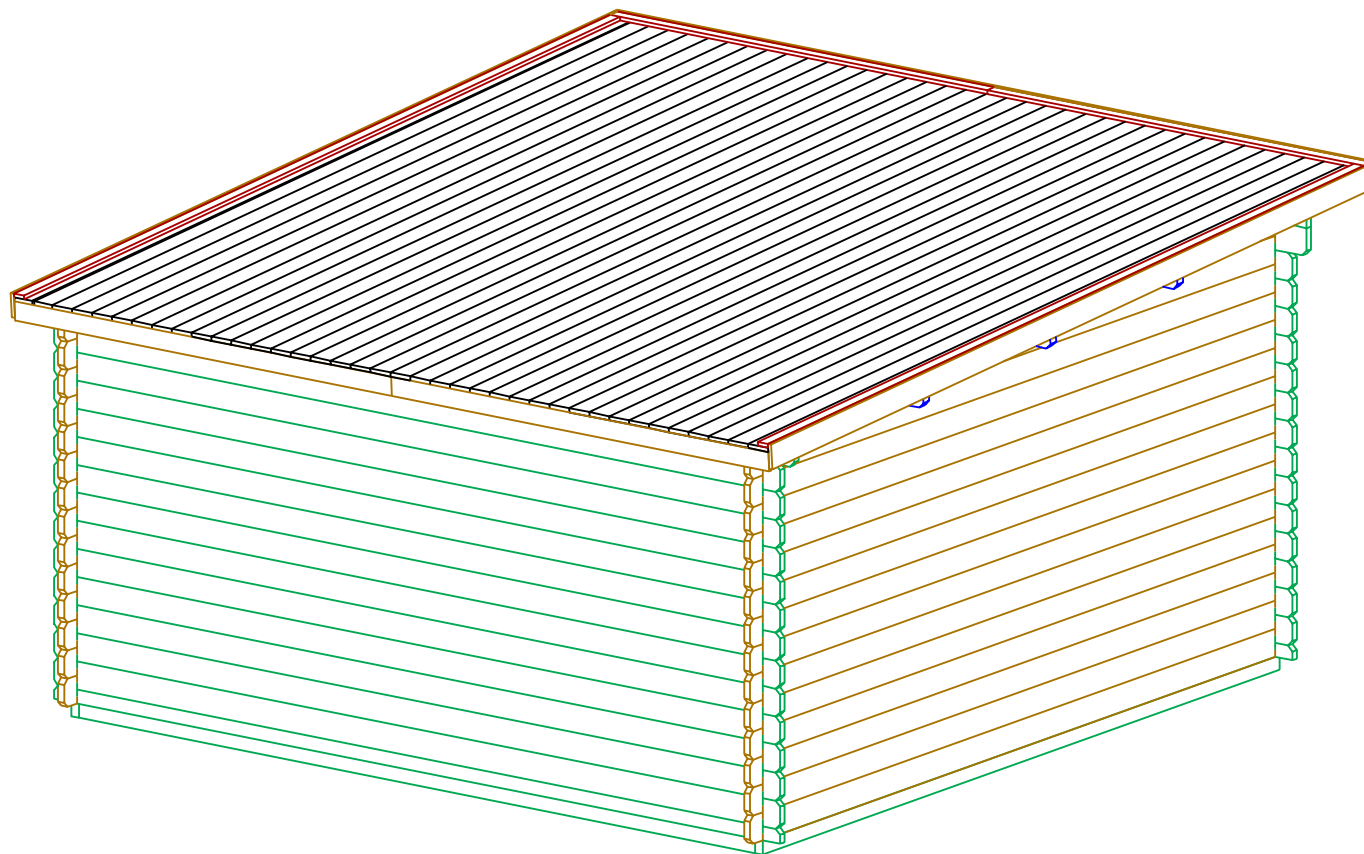

DK 34 4,2x4,2

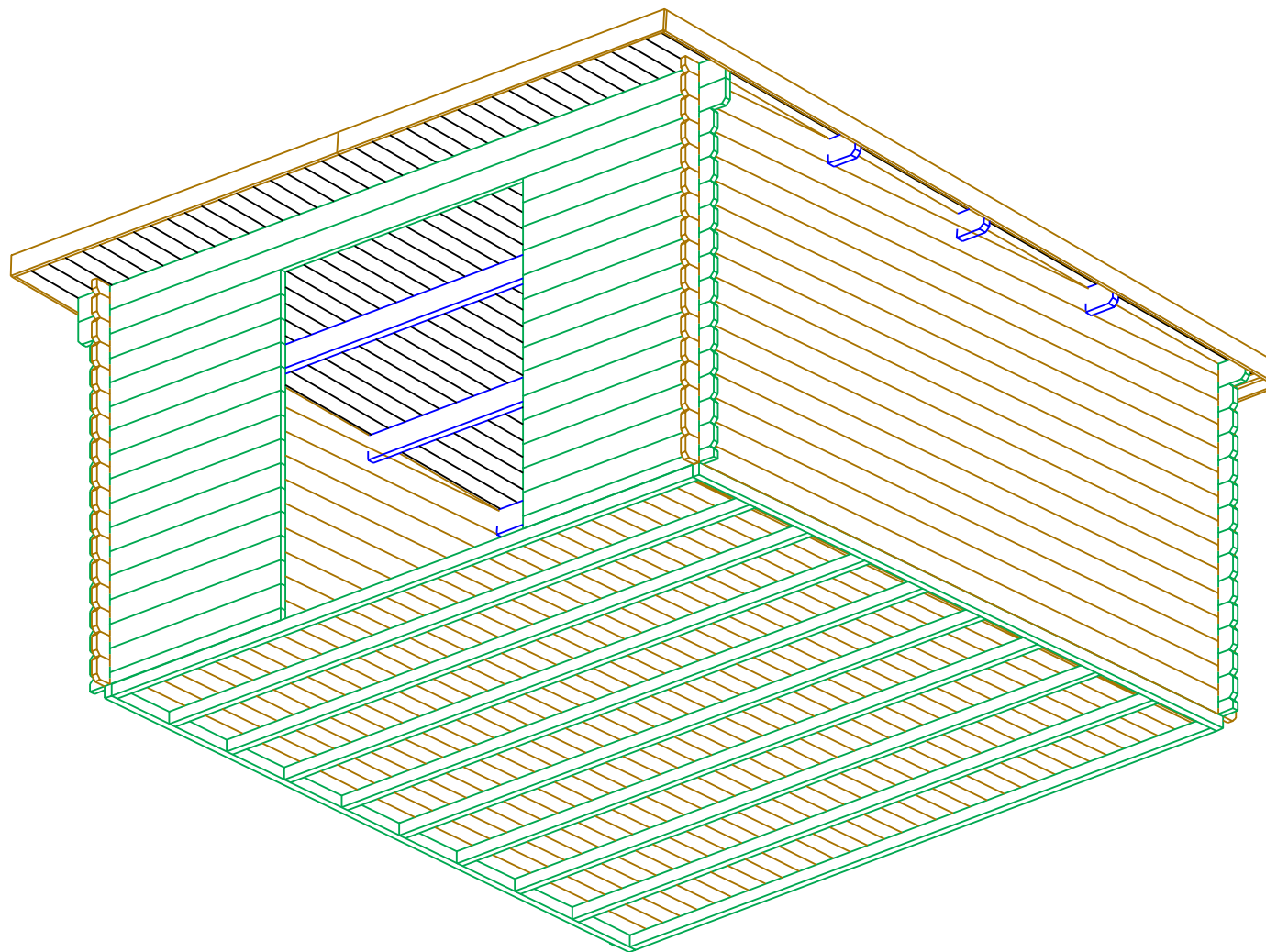

DK 34 4,2x4,2

Plan

Стена B
Wand B
Wall B
Mur B

4200
3932

34 100

100 34

34 100

Стена C
Wand C
Wall C
Mur C

4200

3932

15.46 m²

Стена D
Wand D
Wall D
Mur D

3932

3932

100 34

100 34

1151

1630

Стена A
Wand A
Wall A
Mur A

1151

34 100

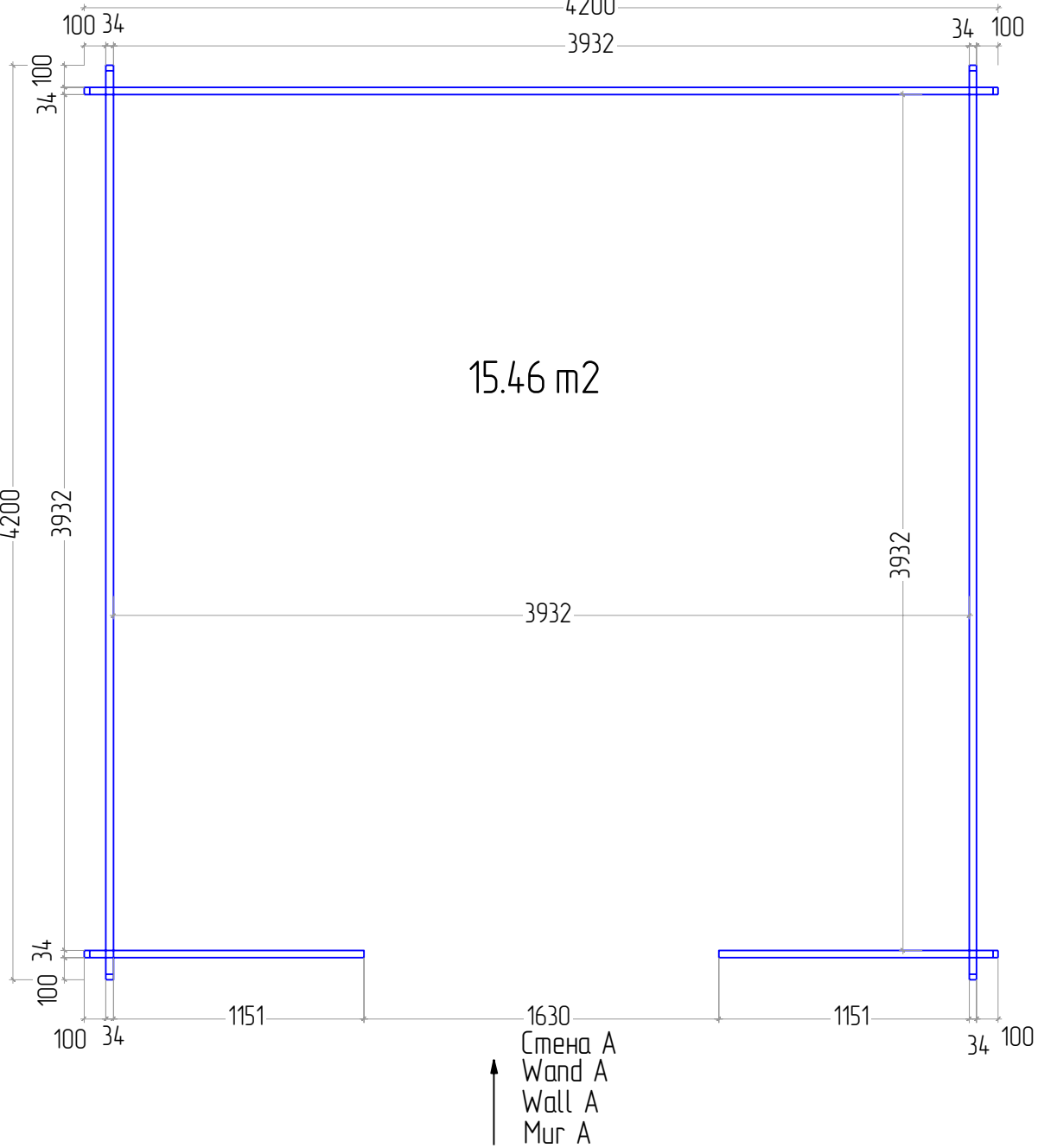

DK 34 4,2x4,2

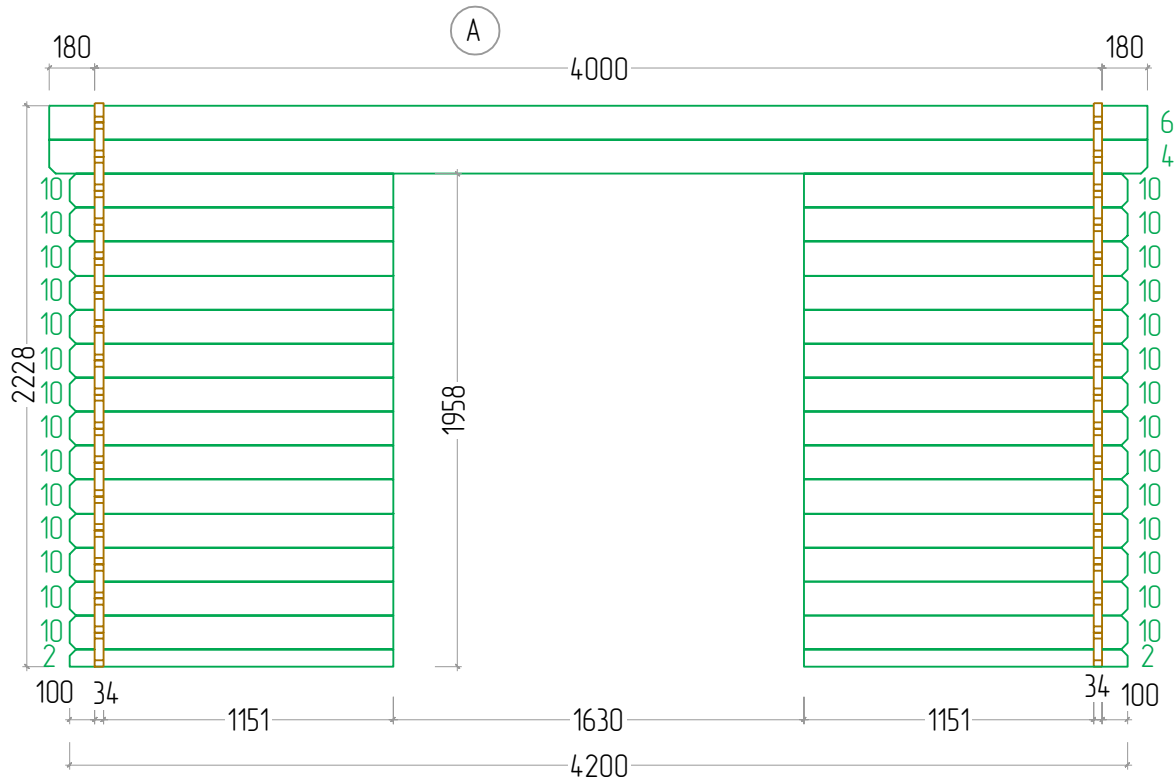

DK 34 4,2x4,2

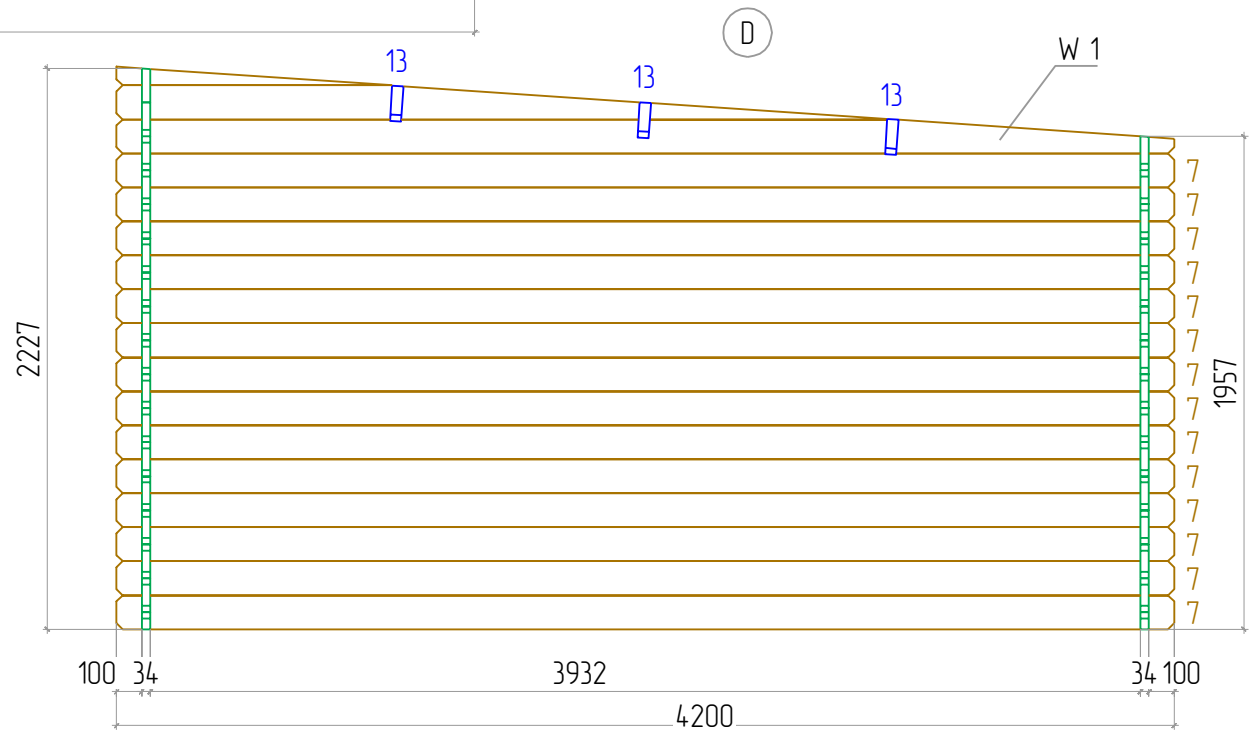
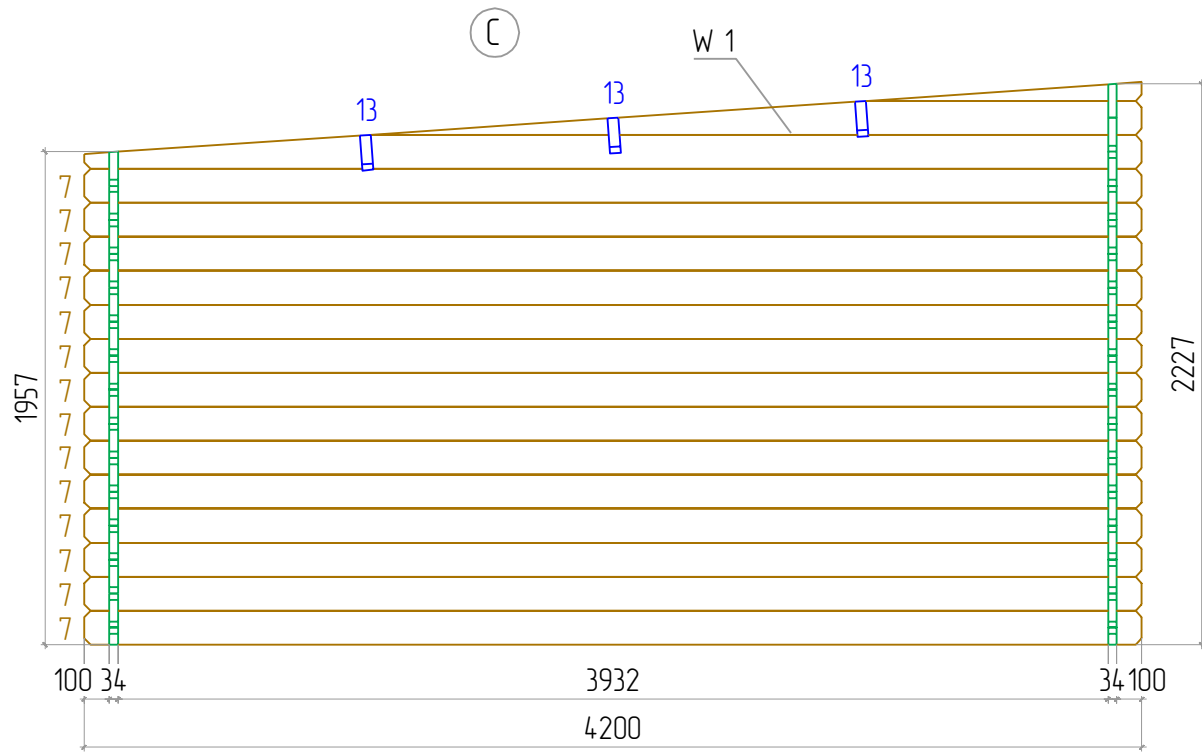

DK 34 4,2x4,2

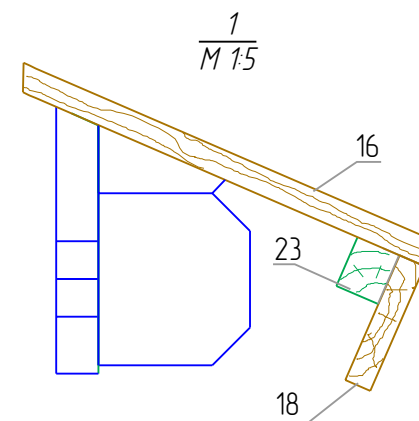
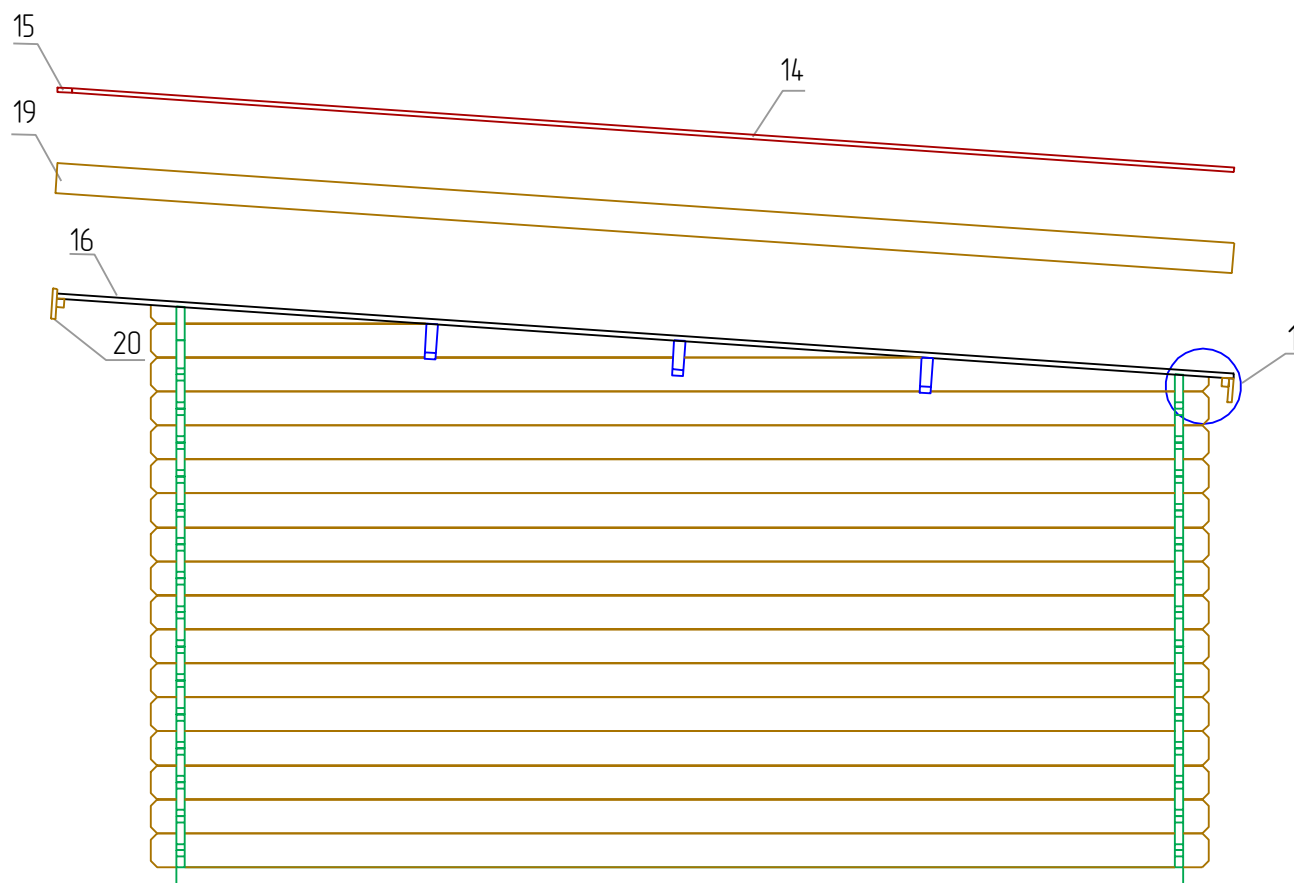

DK 34 4,2x4,2

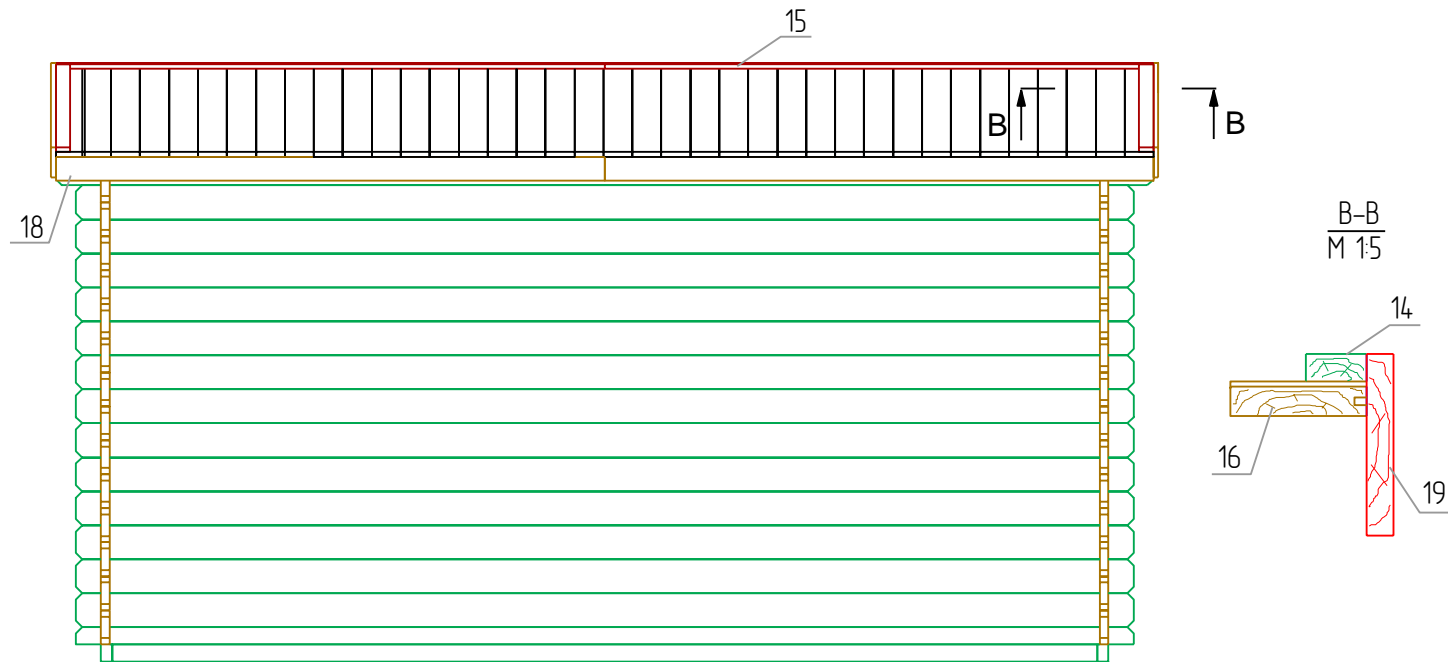

DK 34 4,2x4,2



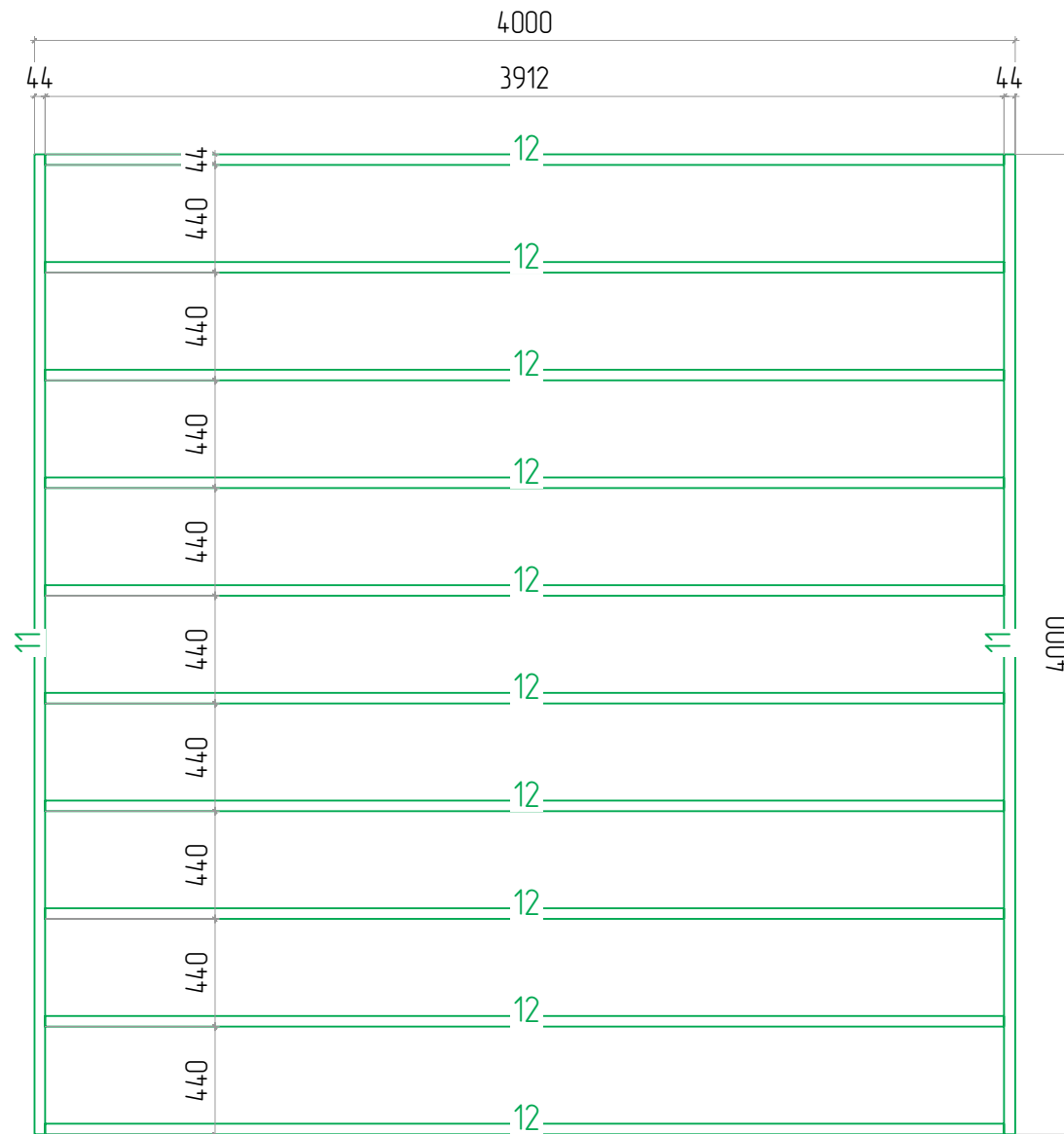





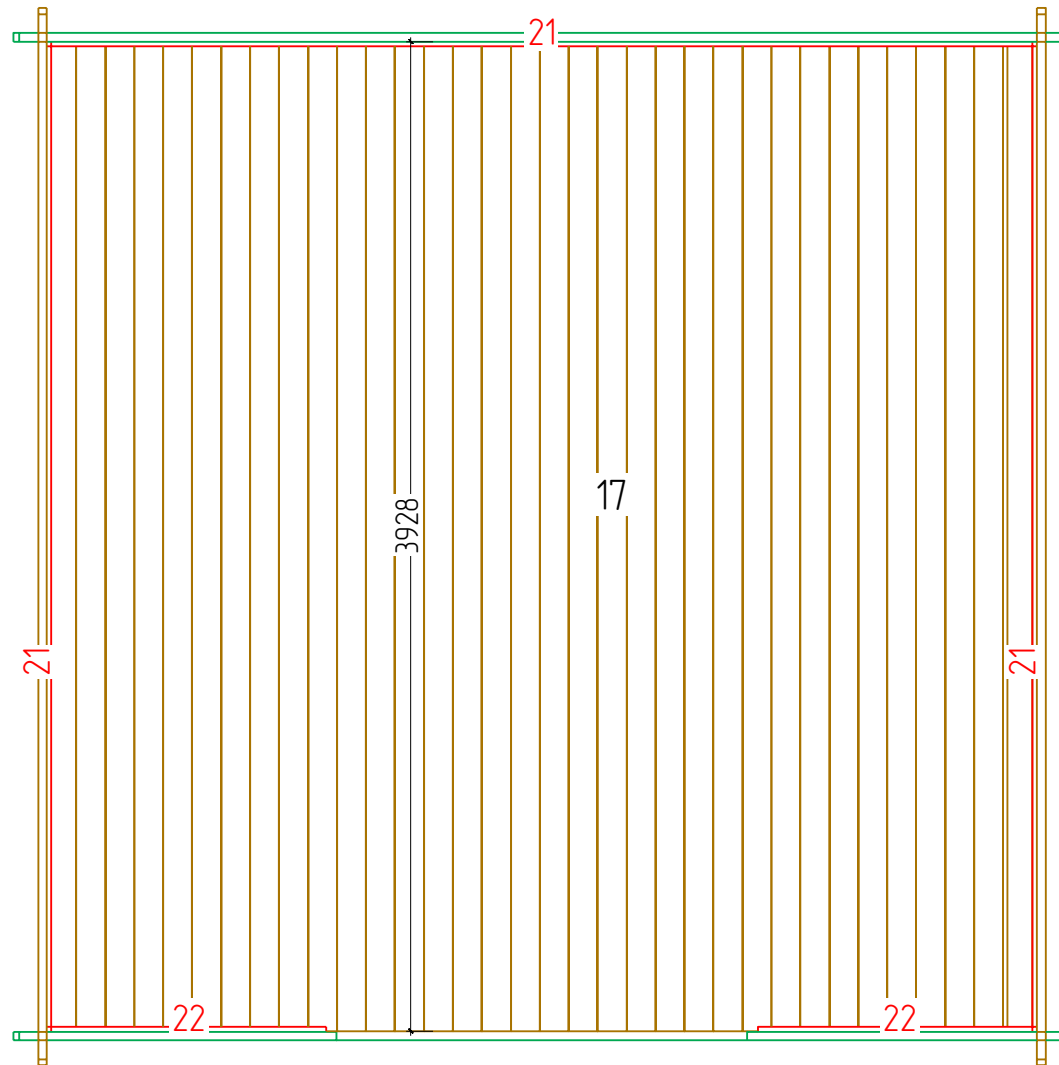

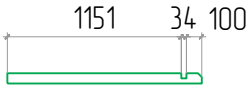
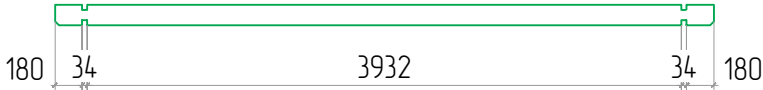
Boarding joist plan
Trummpfan
Lambourde plan

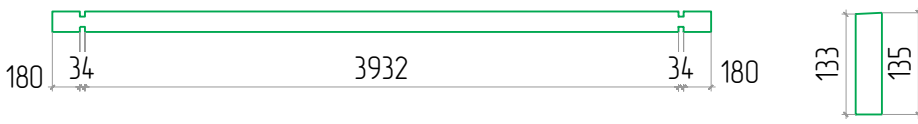



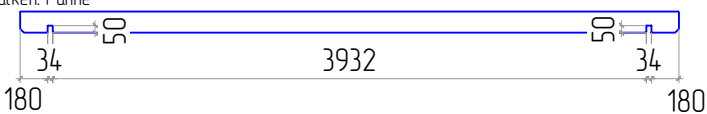





DK 34 4,2x4,2

Plan of the floor board
Plan der Furbodenbretter
Le plan des plaches du plancher



Nº	DK 34 4,2x4,2	Nr.	Profile (mm)	Lenght (mm)
1		1	34x67.5	4200mm
2		2	34x67.5	1285mm
4		1	34x135	4360mm
5		1	34x135	4360mm
6		1	34x135	4360mm
7		42	34x135	4200mm
10		28	34x135	1285mm
11	Foundation Fundament Solive 	2	44x68	4000mm
12	Foundation Fundament Solive 	10	44x68	3912mm
13	Roof beam. Dachbalken. Panne 	3	44x140	4360mm
14	Roofing felt fillet Giebelabschlussbrett Latte de finition couverture 	2	18x58	4624mm
15	Roofing felt fillet Giebelabschlussbrett Latte de finition couverture 	2	18x58	2180mm
16	Roof boards Dachbretter Volige 	38+1	20x115	4682mm

Nº	DK 34 4,2x4,2	Nr.	Profile (mm)	Lenght (mm)
17	Floor boards Fu ssboden Lame de plancher 	35+1	20x115	3928mm
18	Fascia board Giebelblende Planch de rive facade 	2	18x95	2180mm
19	Fascia board Giebelblende Planch de rive facade 	2	18x120	4682mm
20	Fascia board Giebelblende Planch de rive facade 	2	18x120	2198mm
21	Floor edge trim Fu bleisten Plinthe plancher 	3	20x18	3932mm
22	Floor edge trim Fu bleisten Plinthe plancher 	2	20x18	1108mm
23	Roof edge reinforcement Traufenleiste Tasseau 	4	28x34	2180mm
	Door Tur La porte 1958x1630 MM	1		
W1		2		

W1

