



CASSETTA IN LEGNO

3,5x3 (est. 3,7x3,2)

Spessore 34mm

DISEGNI TECNICI

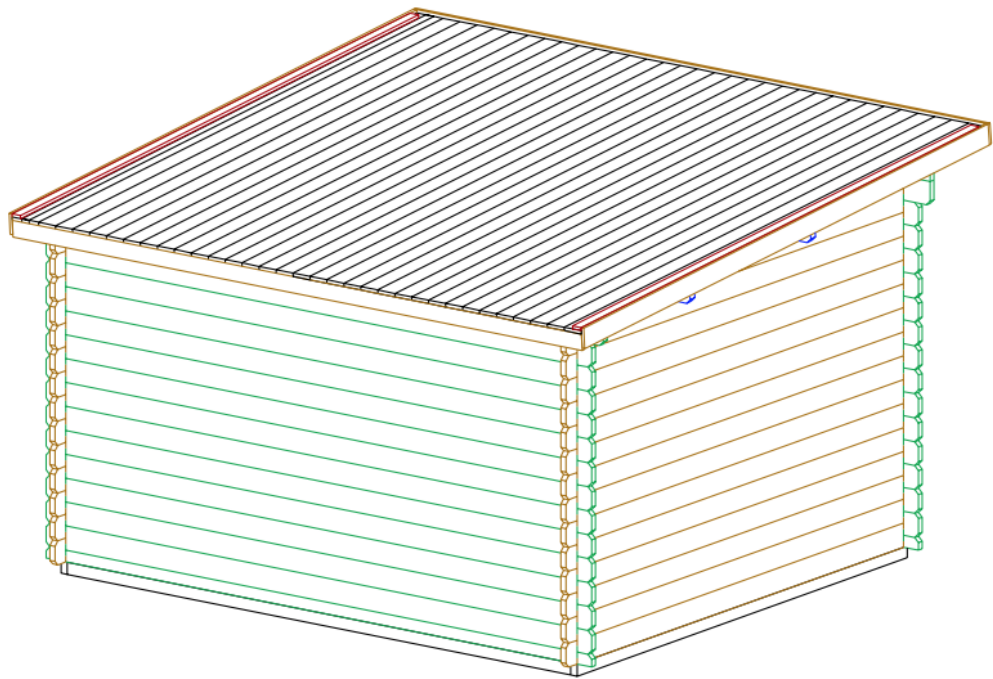
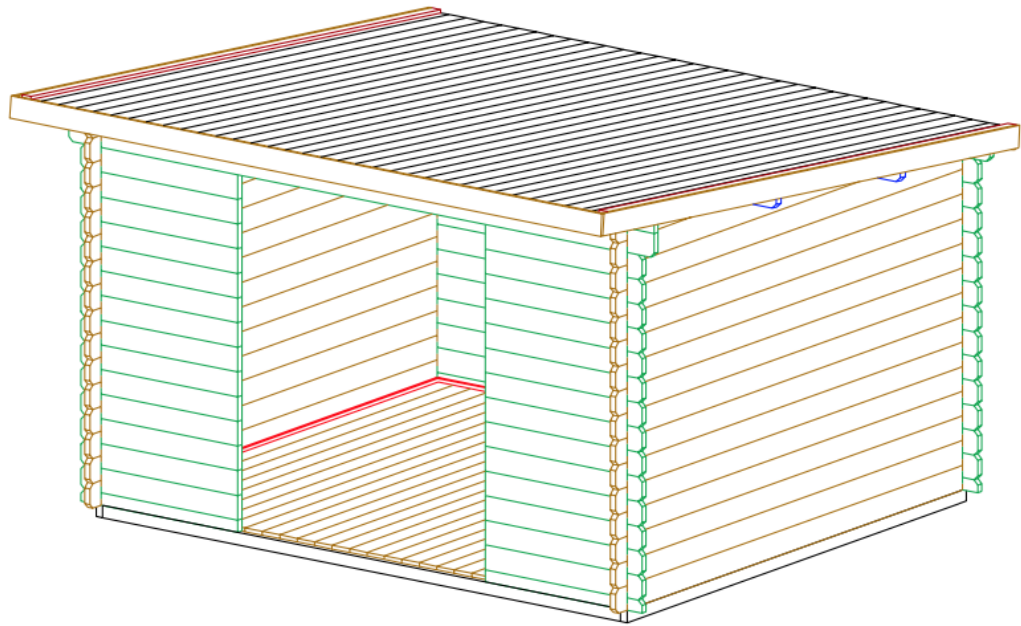

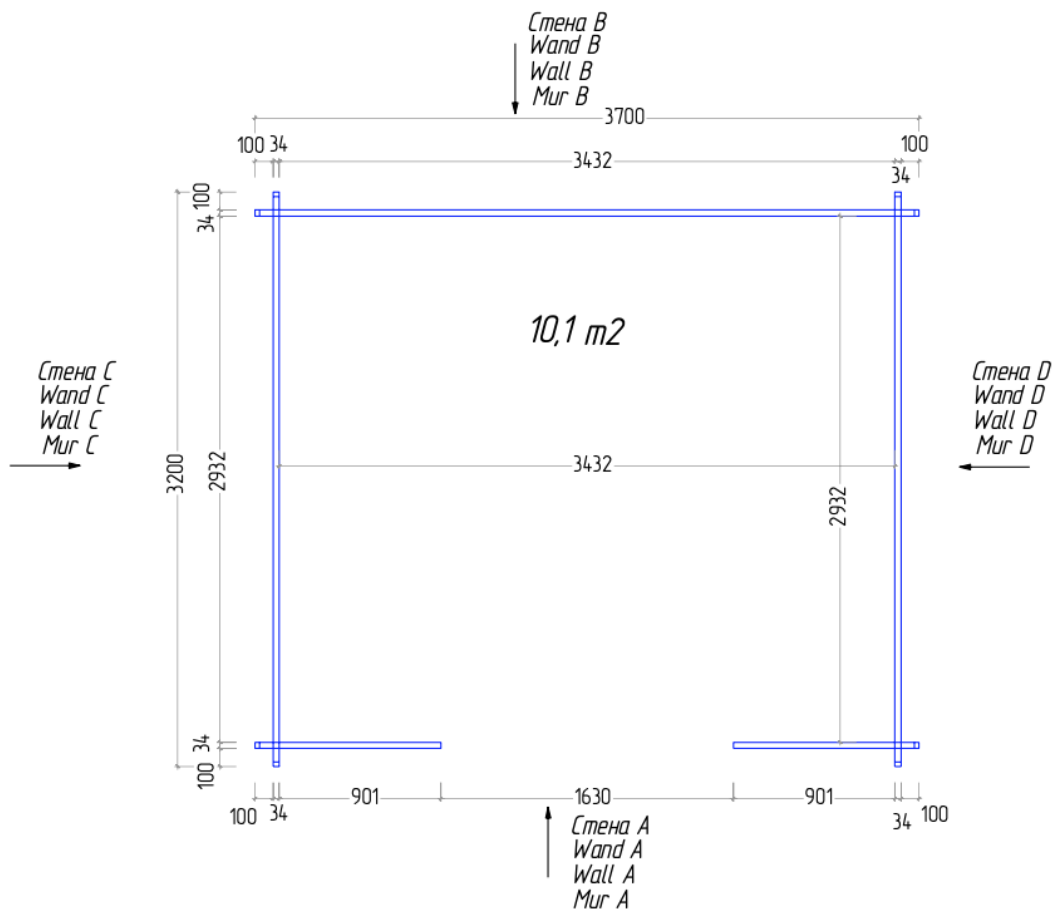
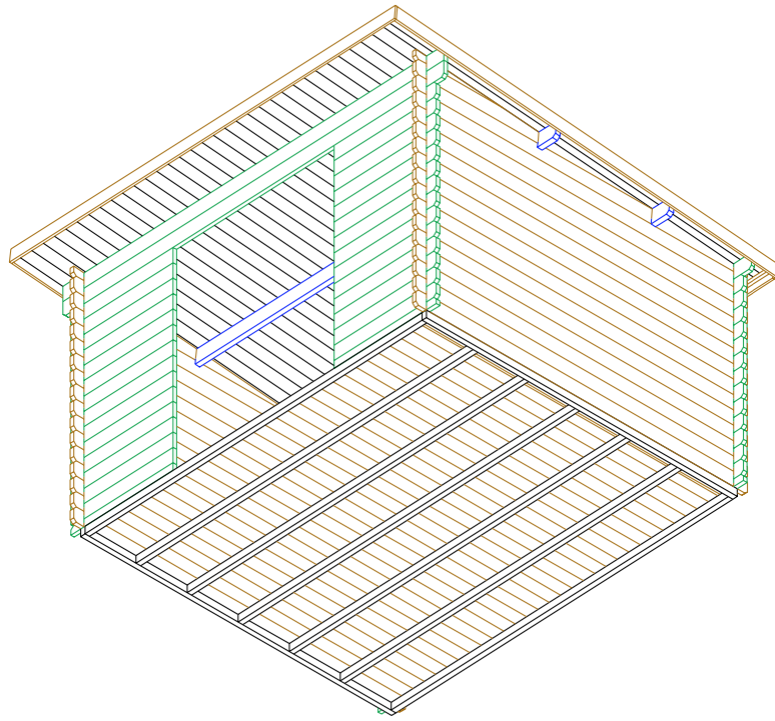

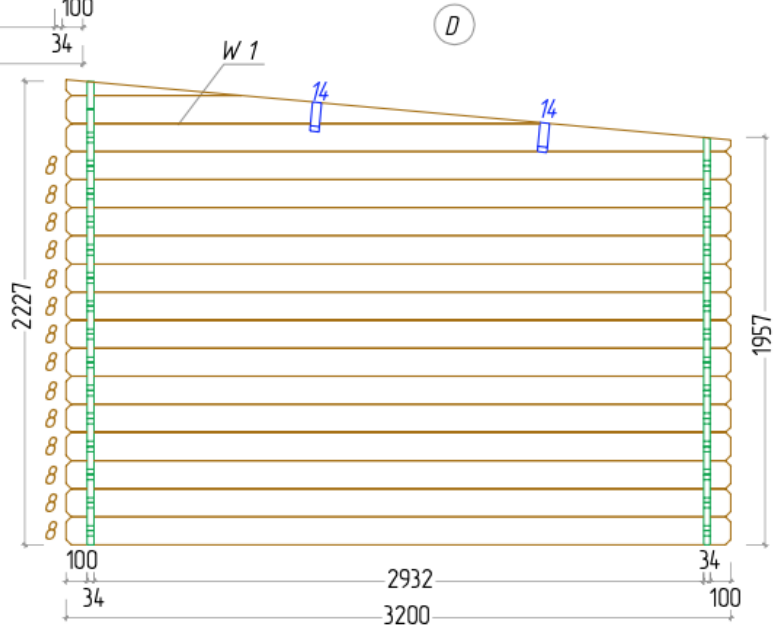
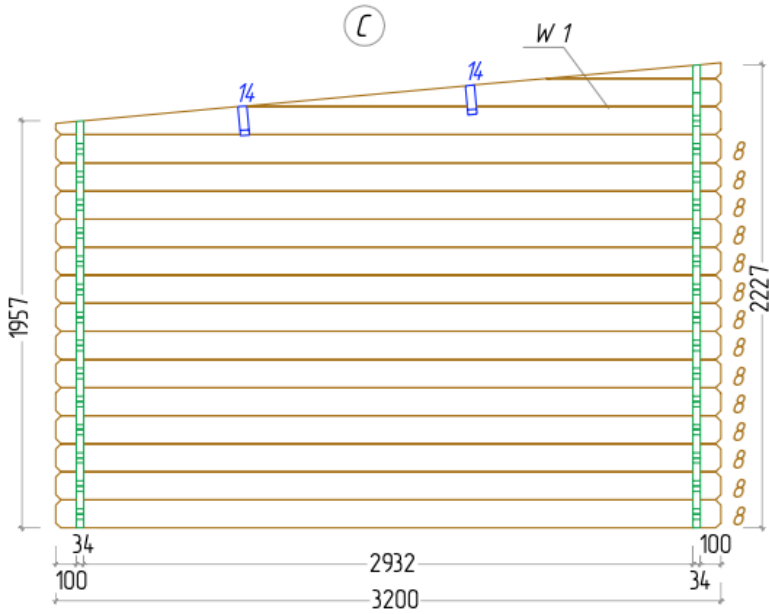

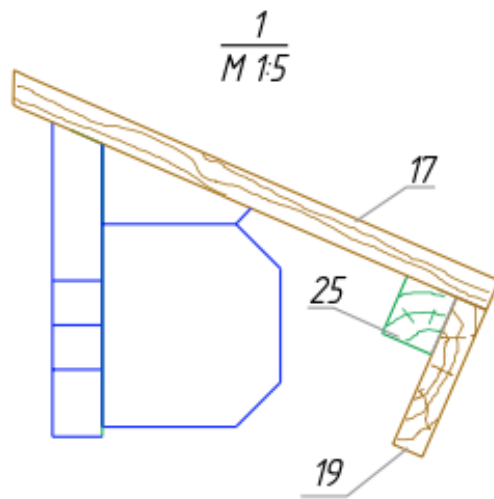
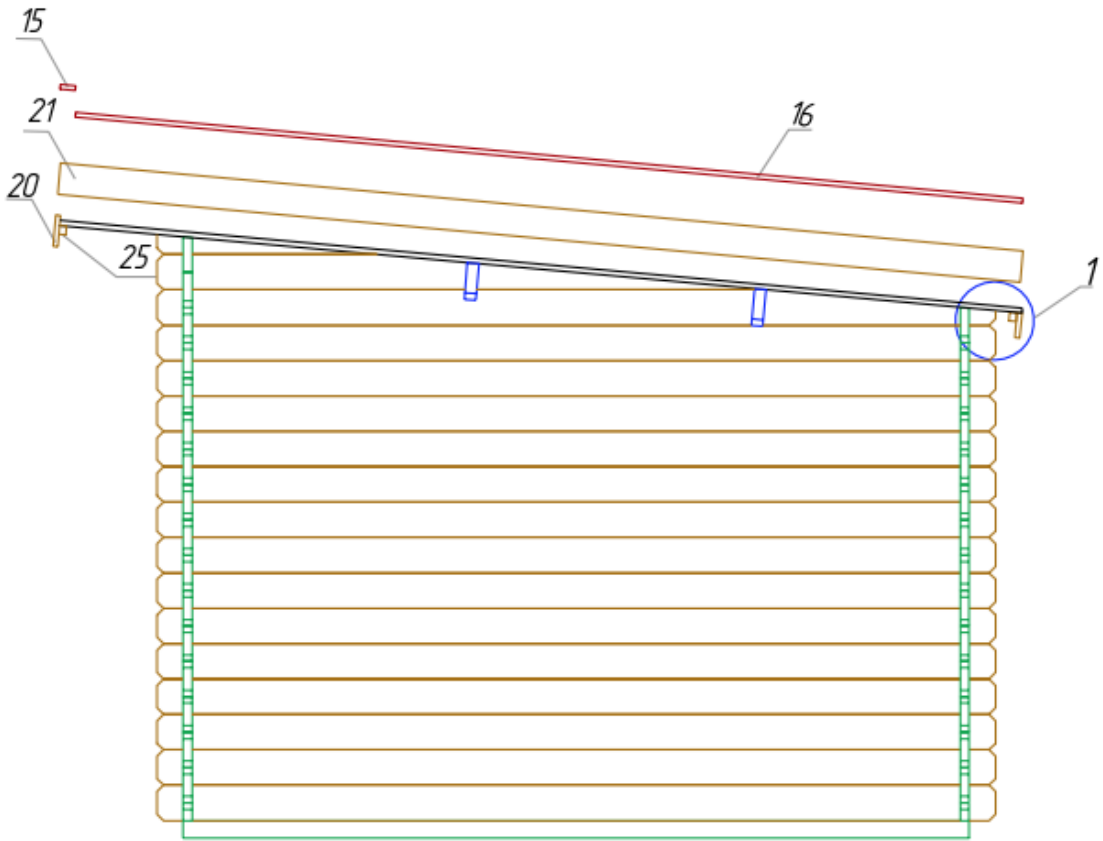

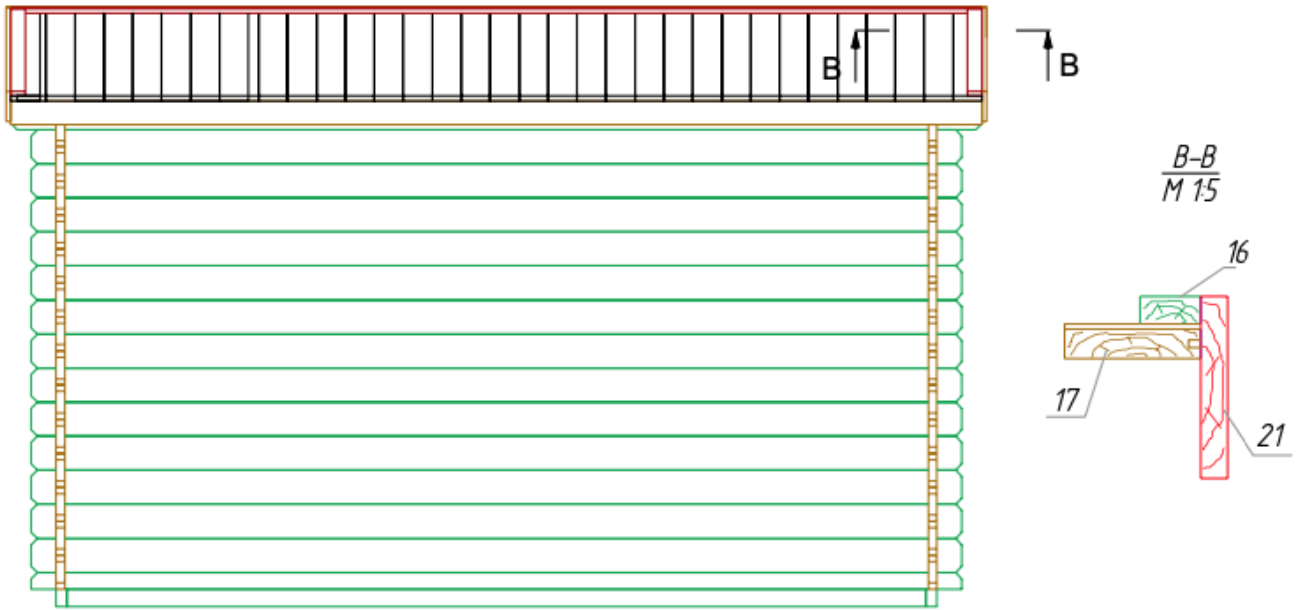

PLANIMETRIA DEI TRAVETTI

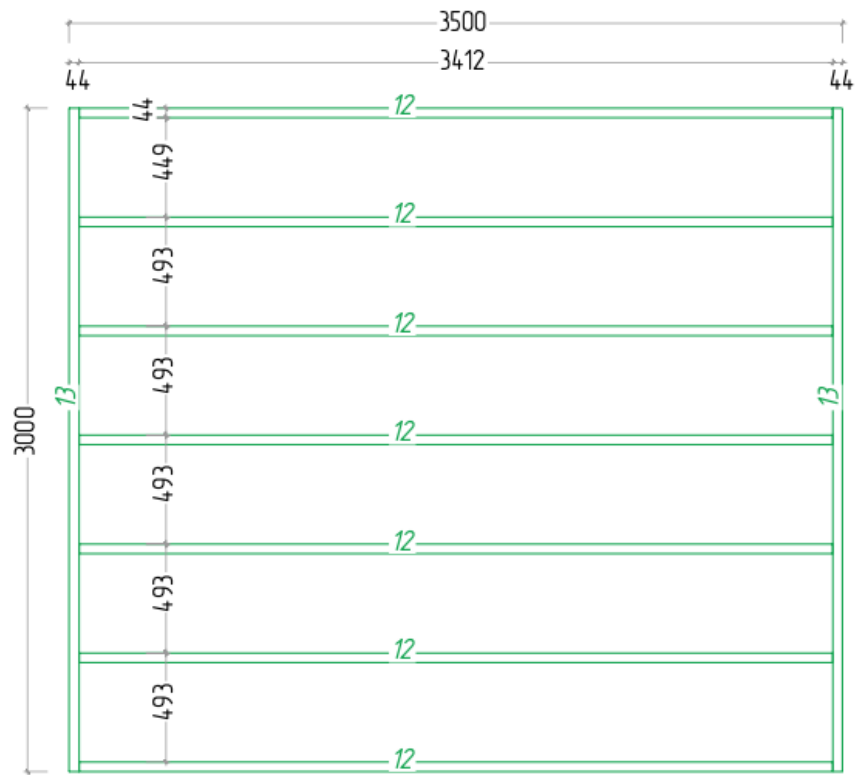

PLANIMETRIA DEL PAVIMENTO

