

GH 34 2x2

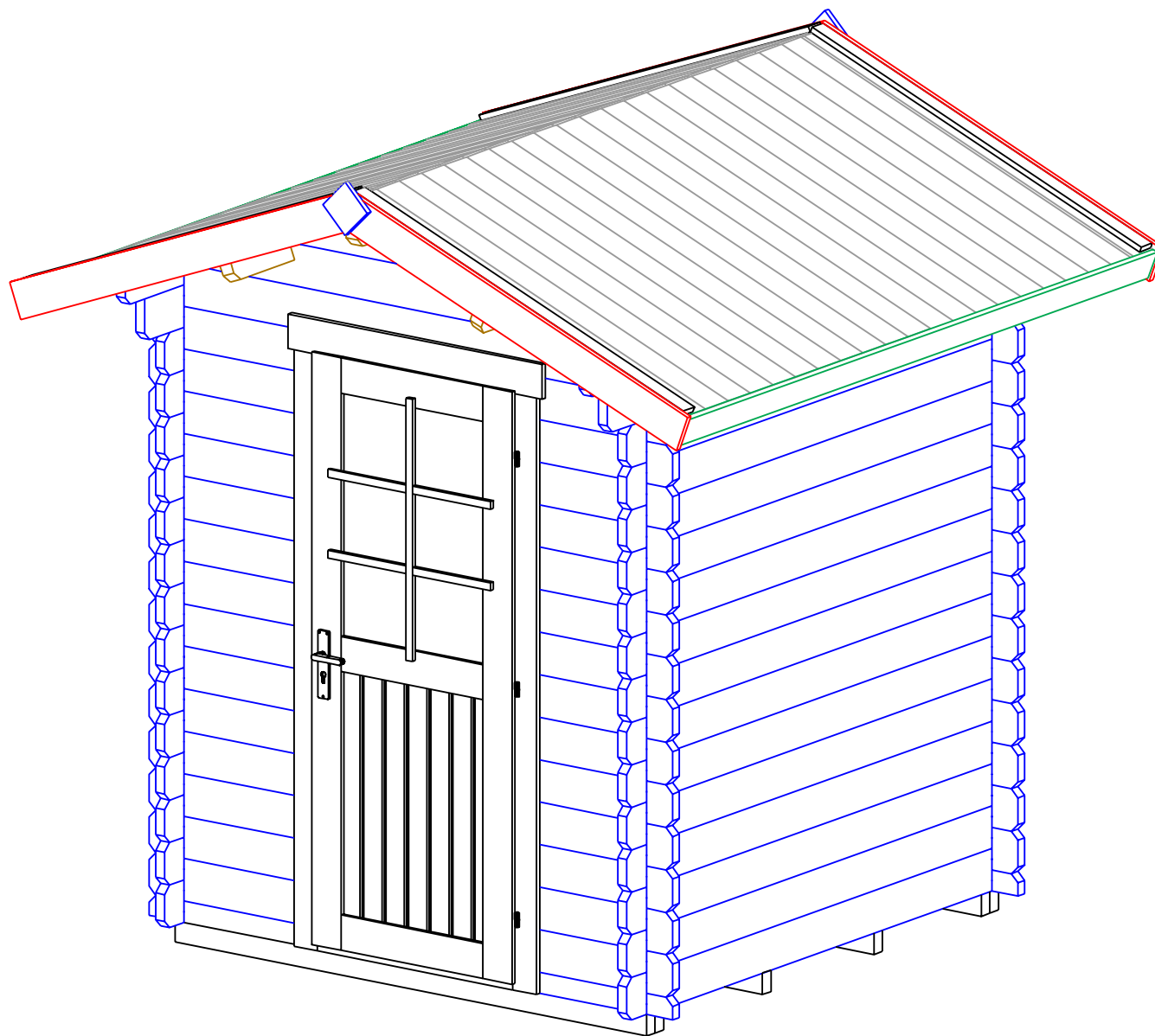

GH 34 2x2

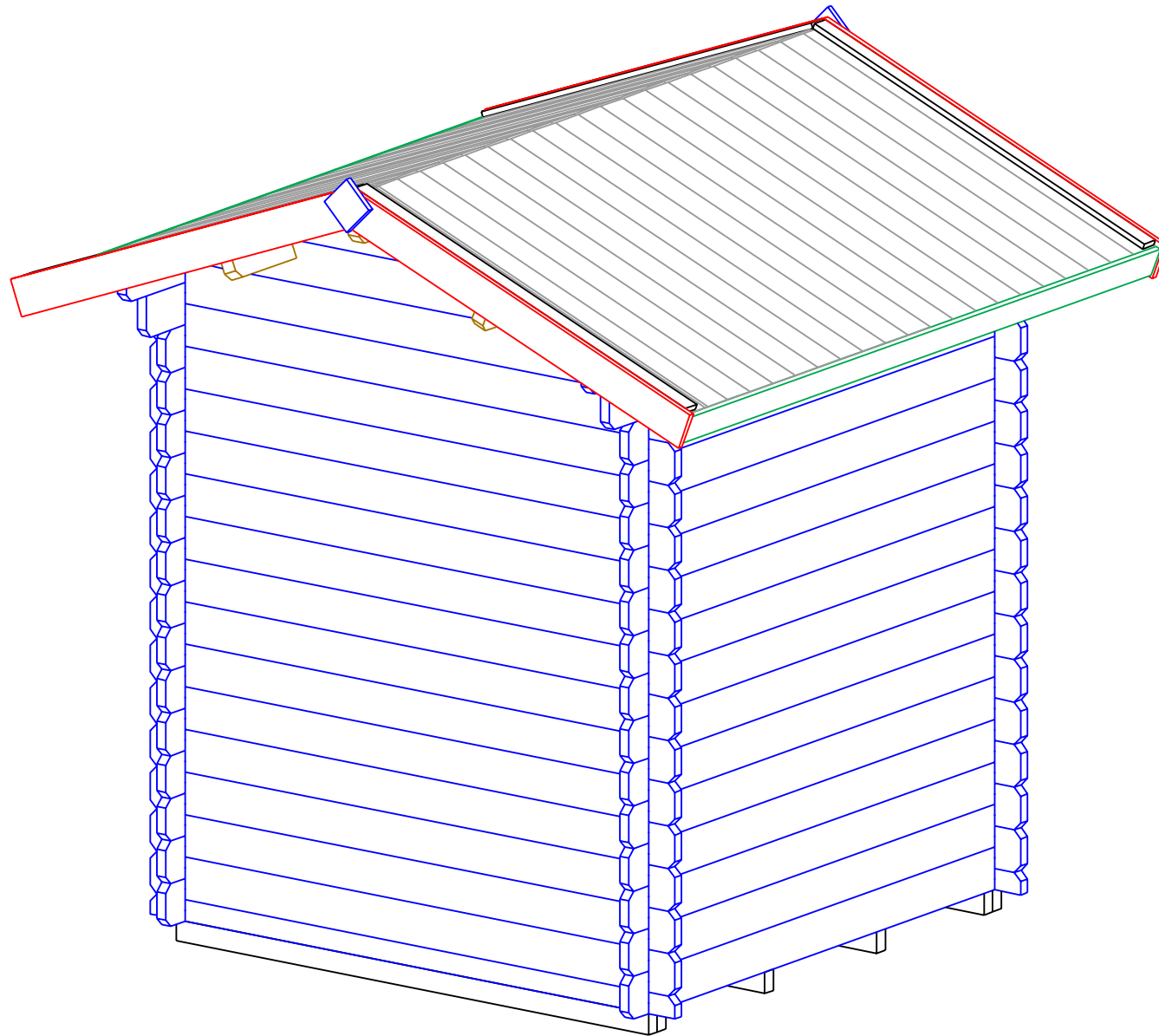

GH 34 2x2

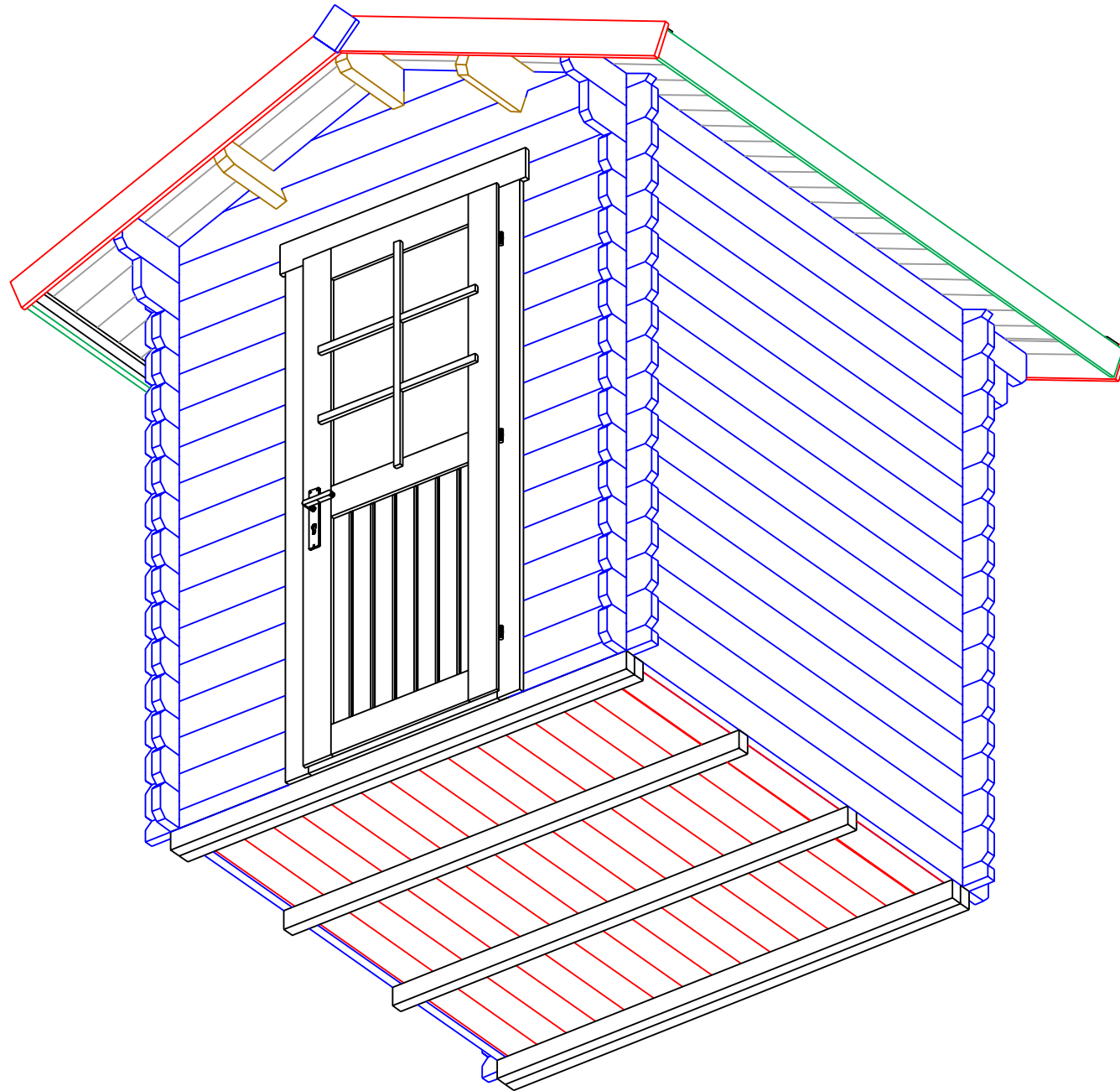

GH 34 2x2
Plan

Parete C

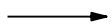

Parete B



Parete D



3.0 m²

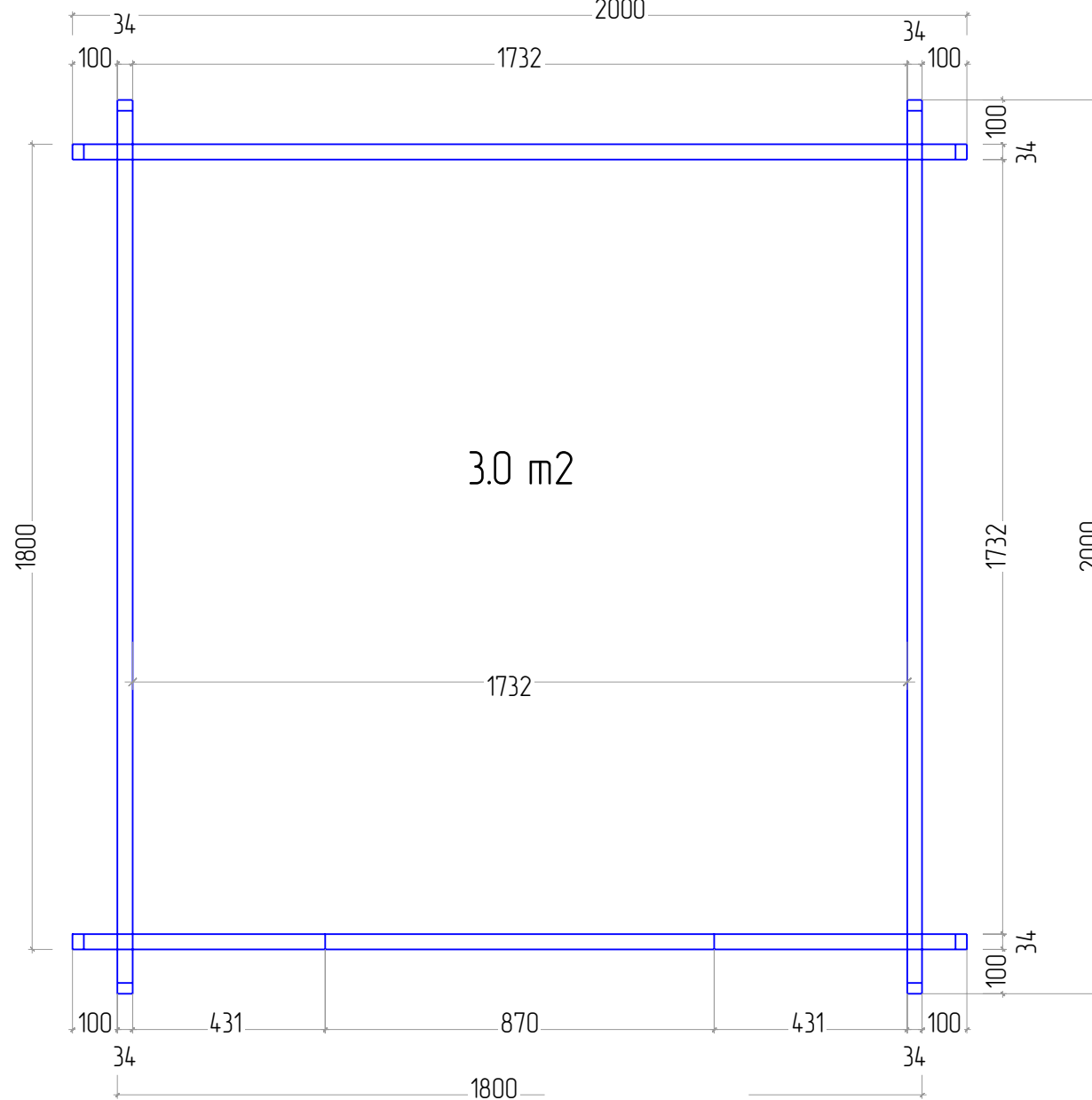

Parete A

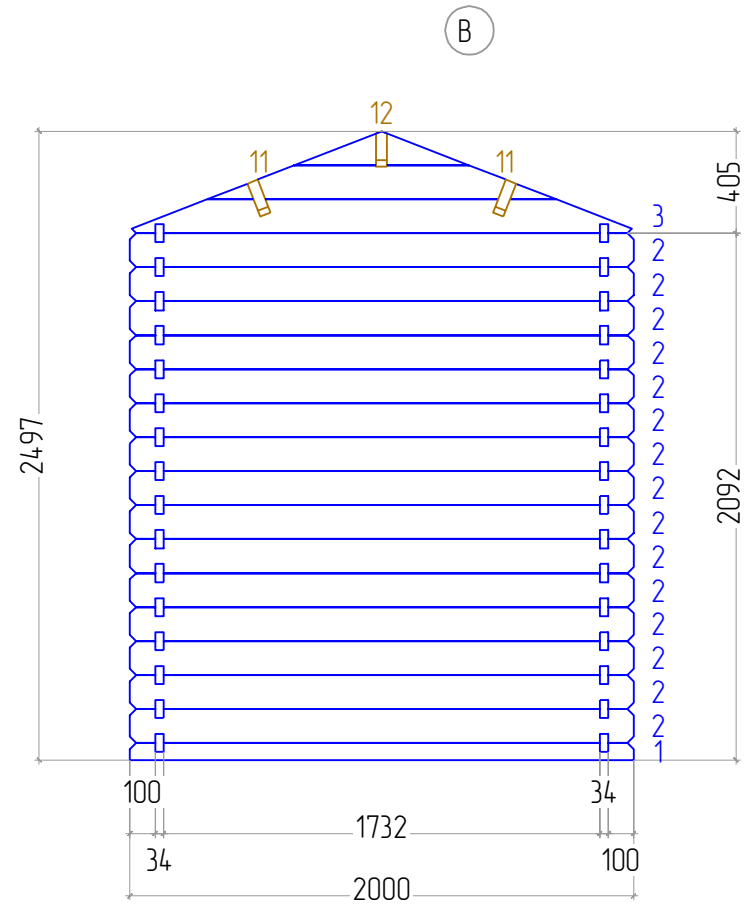
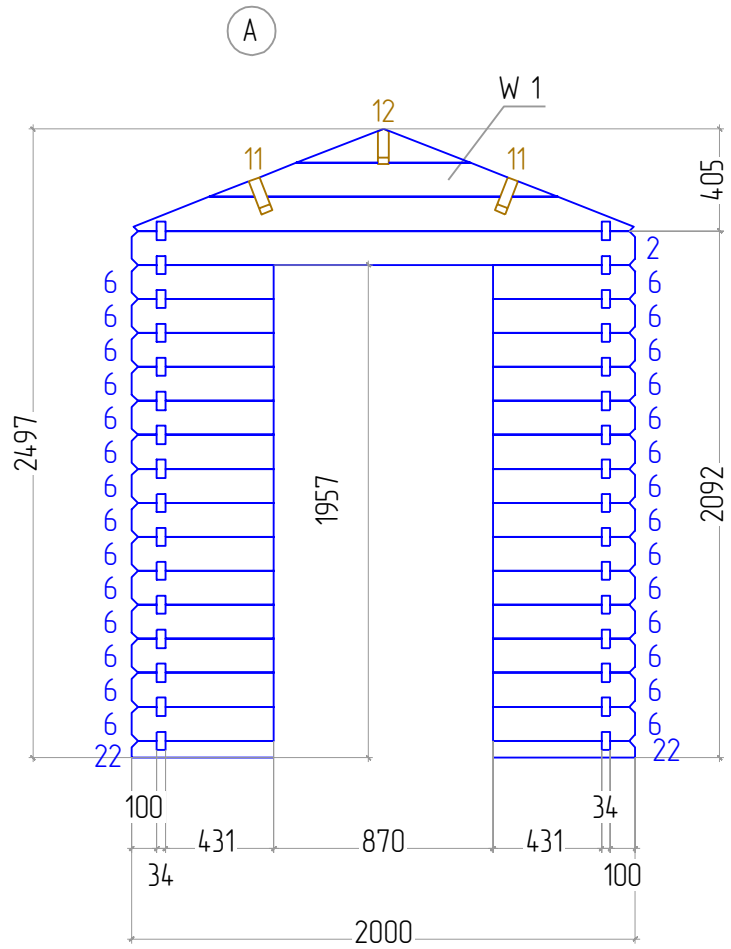

GH 34 2x2

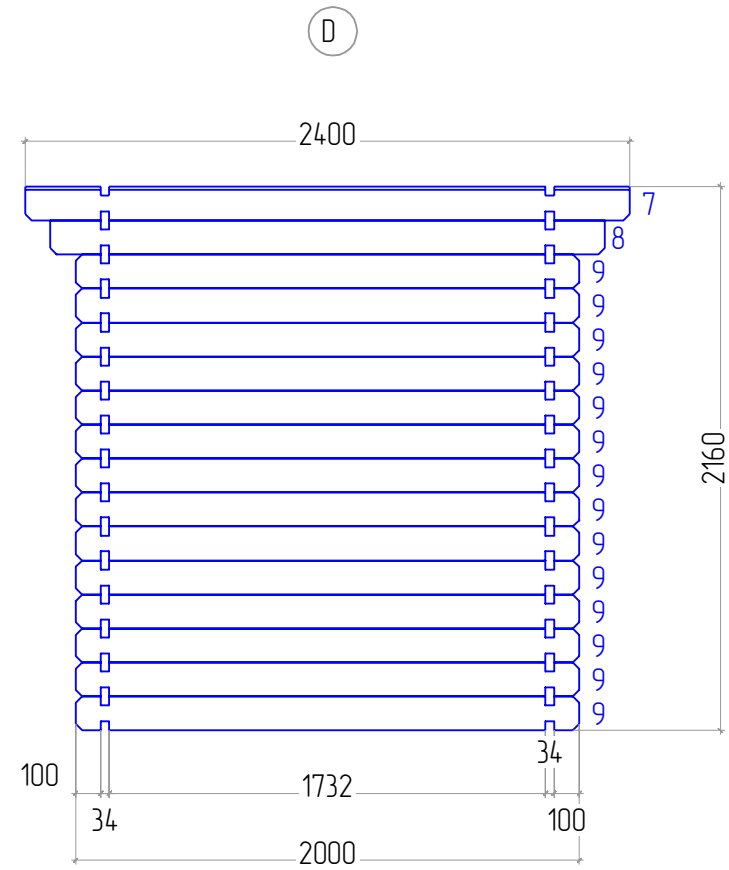
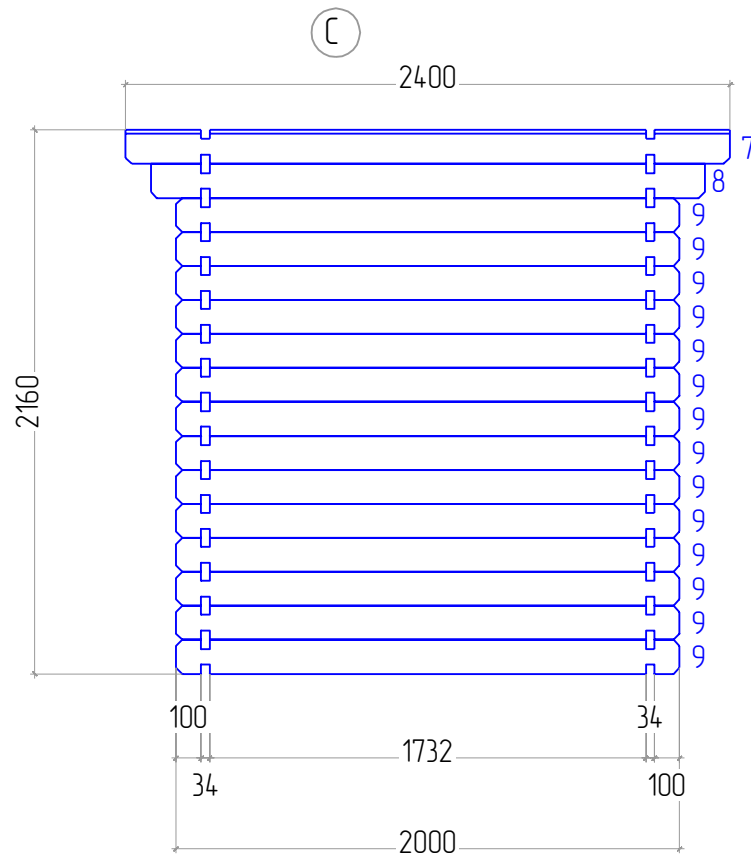

GH 34 2x2

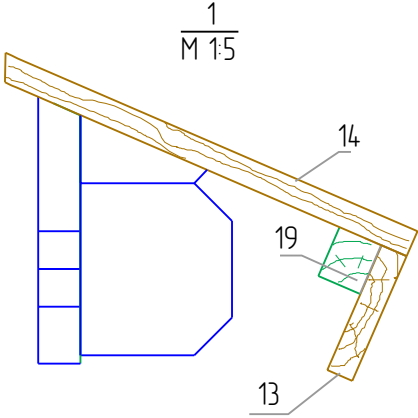
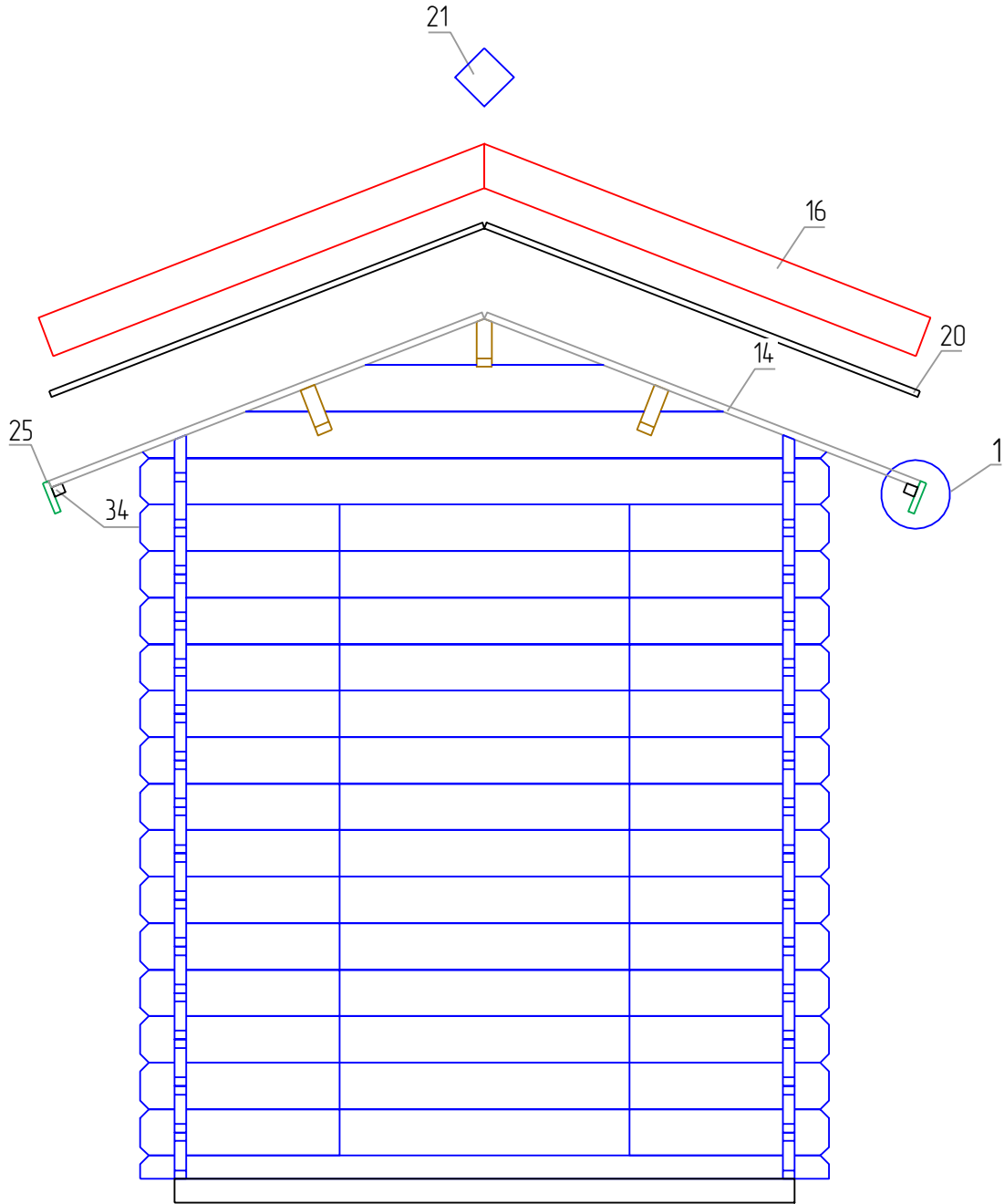

GH 34 2x2

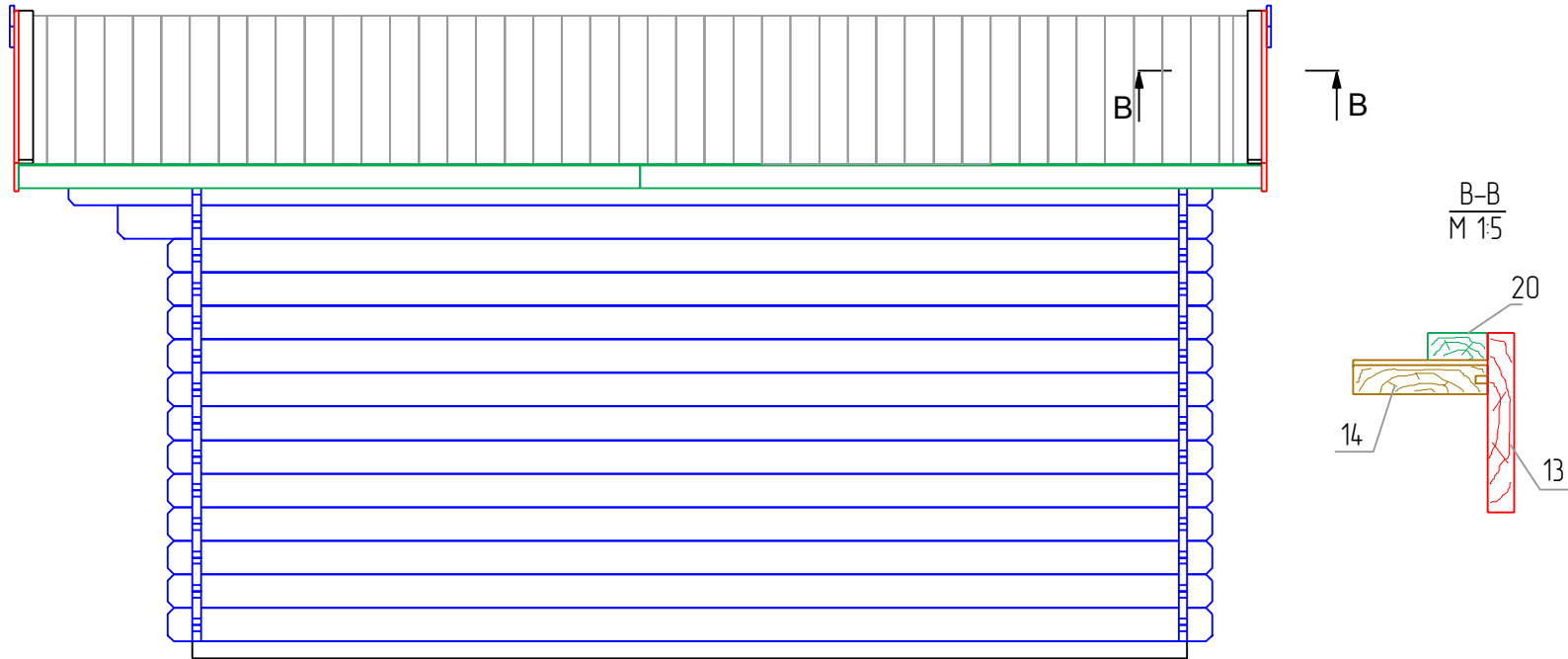

GH 34 2x2

Planimetria dei
travetti di partenza

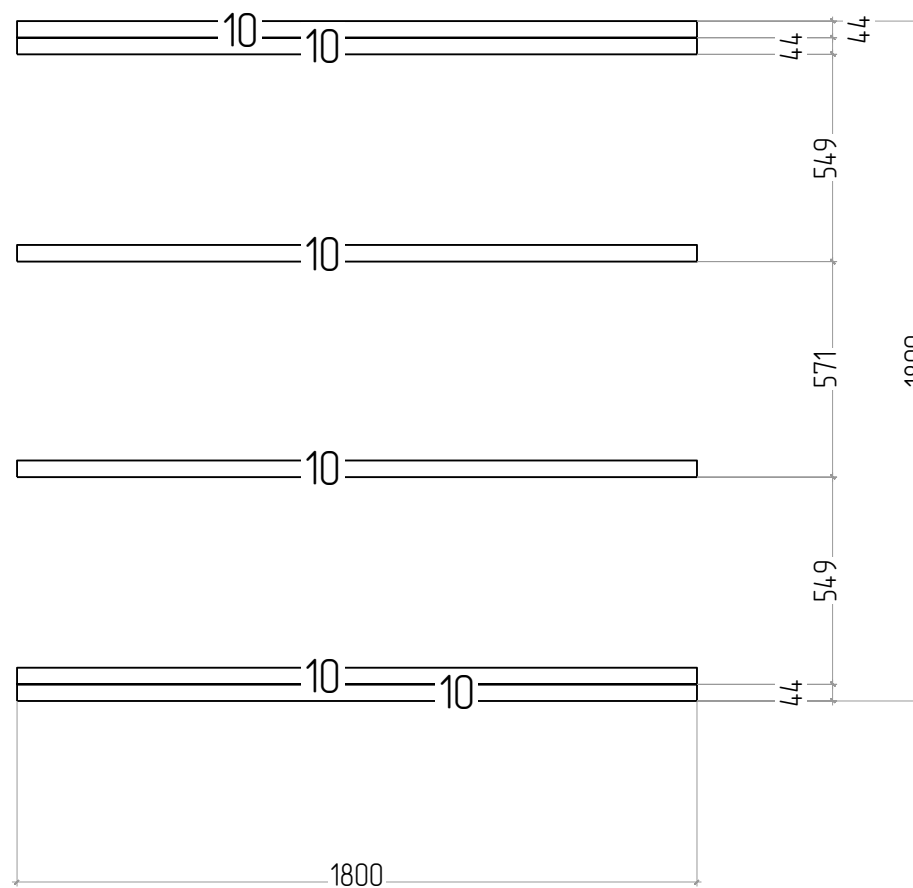

GH 34 2x2

Planimetria del pavimento

